

CHEMIST 100 BE GREEN Combustion Analyzer



CE

USE AND MAINTENANCE MANUAL



Respect your environment: think before printing the full manual on paper

1.0	IMPORTANT INFORMATION	06
1.1	Information about this manual	06
1.2	Danger levels and other symbols	06
2.0	SAFETY	07
2.1	Safety check	07
2.2	Intended use of the product	07
2.3	Improper use of the product	07
2.4	Precautions for the usage of the Li-Ion battery package	07
3.0	WORKING PRINCIPLE	08
3.1	General overview of the Analyzer	08
4.0	DESCRIPTION OF THE PRODUCT	09
4.1	Working principle	09
4.2	Measurement cells	09
4.3	Fuel types	09
4.4	Sample treatment	09
4.5	Pressure sensor, piezoelectric, temperature compensated	09
4.6	Suction pump	09
4.7	Draft measurement with sensor automatic autozero	09
4.8	Smoke measurement	10
4.9	Temperature measurements	10
4.10	Bluetooth® connection	10
4.11	IR connection	10
5.0	COMPONENTS DESCRIPTION	11
5.1	Instrument interface	11
6.0	TECHNICAL SPECIFICATIONS	13
6.1	Technical specifications	13
6.2	Measurement and Accuracy Ranges	14
7.0	USING THE FLUE GAS ANALYZER	15
7.1	Preliminary operations	15
7.2	Warning	15
7.3	Analyzer power supply	15
7.3.1	Internal battery charge level	15
7.3.2	Use with external power pack	16
7.4	QR code generation	16
7.5	Connection diagram	17
8.0	FLUE GAS ANALYSIS	18
8.1	The flue gas analysis	18
8.1.1	Switching on the instrument and auto-calibration	18
8.1.2	Preliminary operations	19
8.1.3	Inserting the probe inside the stack	19
8.1.4	Performing the combustion analysis - Manual mode	20
8.1.5	Performing the combustion analysis - Auto Mode	21
8.1.6	End of Analysis	23

9.0	INSTRUMENT PARAMETER	25
9.1	Parameter menu	25
10.0	MEASURES	26
10.1	Menu→Measures	26
10.2	Menu→Measures→Comb. analysis	27
10.3	Menu→Measures→Draft	28
10.4	Menu→Measures→CO air	29
10.5	Menu→Measures→Pressure	30
11.0	MEMORY	31
11.1	Menu→Memory	31
12.0	CONFIGURATION	34
12.1	Menu→Configuration	34
12.2	Menu→Configuration→Analysis	35
12.2.1	Menu→Configuration→Analysis→Fuel	36
12.2.2	Menu→Configuration→Analysis→Condensation	37
12.2.3	Menu→Configuration→Analysis→O2 Reference	38
12.2.4	Menu→Configuration→Analysis→Measure units	39
12.2.5	Menu→Configuration→Analysis→Autozero	40
12.3	Menu→Configuration→Instrument	43
12.3.1	Menu→Configuration→Instrument→Display	44
12.3.2	Menu→Configuration→Instrument→On site calib.	45
12.3.3	Menu→Configuration→Instrument→Clock	50
12.4	Menu→Configuration→Print	52
12.5	Menu→Configuration→Language	54
12.6	Menu→Configuration→Restore	55
13.0	DIAGNOSTIC	56
13.1	Menu→Diagnostic	56
13.2	Menu→Diagnostic→Sensors	57
13.3	Menu→Diagnostic→Gas probe	58
13.4	Menu→Diagnostic→Hardware	59
14.0	INFO SERVICE	60
14.1	Menu→Info service	60
15.0	SENSORS	61
15.1	Gas sensors life	61
15.2	Gas sensors life table	61
16.0	MAINTENANCE	62
16.1	Routine maintenance	62
16.2	Preventive maintenance	62
16.3	Replacing the gas sensors	62
17.0	TROUBLESHOOTING	65
17.1	Troubleshooting guide	65

18.0 SPARE PARTS AND SERVICING	67
18.1 Spare parts	67
18.2 Accessories	67
18.3 Service Centers	67
ANNEX A - Data Management with “SMARTFLUE LITE MOBILE” APP	68
ANNEX B - Optional measures list	70
ANNEX C - Coefficients of the fuels and Formulas	72
ANNEX D - Declaration of Conformity	73
WARRANTY CERTIFICATE	75

SEITRON S.p.A. a socio unico - ALL RIGHTS RESERVED -

Total or partial reproduction of this document by any means (including photocopying or storage on any electronic medium) and transmittal of same to third parties in any manner, even electronically, is strictly prohibited unless explicitly authorized in writing by SEITRON S.p.A. a socio unico

1.0 IMPORTANT INFORMATION

1.1 Information about this manual

- This manual describes the operation, the features and the maintenance of Chemist 100 BE GREEN Combustion Analyzer .
- Read this operation and maintenance manual before using the device. The user must be familiar with the manual and follow the instructions carefully.
- This use and maintenance manual is *subject to change due to technical improvements - the manufacturer assumes no responsibility for any mistakes or misprints.*

1.2 Danger levels and other symbols

	The magnets on the back of the instrument can damage credit cards, hard drives, mechanical watches, pacemakers, defibrillators and other devices proven sensitive to magnetic fields. It is recommended to keep the instrument at a distance of at least 25cm away from these devices.
---	--

Symbol	Meaning	Comments
--------	---------	----------



WARNING

Read information carefully and be ready to take appropriate safety procedures!

To prevent any danger from personnel or other goods. Not following the instructions of this manual may cause danger to people, the installation or the environment and may lead to liability loss.



Information on LCD

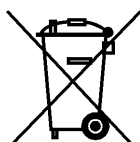

Disposal Indications

Dispose of the battery pack at the end of its working life only at the dedicated collecting bin.

This device must not be disposed as a urban litter.
Dispose of the device according to national standards.



Keyboard with preformed keys with main control functions.

2.1 Safety check

- Use the product according to what is described in chapter “Intended purpose”.
- During the instrument operation, comply with the current standards.
- Do not use the instrument if damaged on the outer cover, on the power supply plug or on the cables.
- Do not take measures on non-isolated components / voltage conductors.
- Keep the instrument away from solvents.
- For the maintenance of the instrument, strictly comply with what’s described in this manual at the “Maintenance” chapter.
- All the interventions not specified in this manual, may be performed exclusively by Seitron assistance centers. Otherwise, Seitron declines every responsibility about the normal operation of the instrument and on the validity of the several homologations.

2.2 Intended purpose

This chapter describes the areas of application for which the CHEMIST 100 BE GREEN is intended.

Using the CHEMIST 100 BE GREEN in other application areas is on the risk of the operator and the manufacturer assumes no responsibility and liability for loss, damage or costs which could be a result. It is mandatory to read and pay attention to the operating/maintenance manual.

All products of the series CHEMIST 100 BE GREEN are handheld measuring devices in professional flue gas analysis for:

- Small furnaces (burning oil, gas, wood, coal)
- Low-temperature and condensing boilers
- Gas heaters

2.3 Improper use of the product

CHEMIST 100 BE GREEN should not be used:

- As safety alarm instrument
- In classified zones with explosion risk (ATEX or equivalent)

2.4 Precautions for the usage of the Li-Ion battery package

Pay attention while handling the battery package inside the instrument; a wrong or improper usage may lead to heavy physical injuries and/or damages:

- Do not create a short circuit: make sure that the terminals are not in contact with metal or other conductive materials during transportation or storage.
- Do not apply with inverted polarities.
- Do not make the batteries come in contact with liquid substances.
- Do not burn the batteries nor expose to temperature higher than 140 °F (60°C).
- Do not try to disassemble the battery.
- Do not hit or pierce the batteries. Improper use can cause damages and internal short circuits not always externally visible. If the battery package has fallen or has been hit with an hard surface, regardless the external shell condition:
 - Stop operation;
 - Dispose of the battery in compliance with the disposal instructions;
- Do not use batteries with leaks or damages.
- Charge the batteries only inside the instrument.
- If a malfunction occurs or if over heating signs occur, immediately remove the battery package from the instrument. Warning: the battery may be hot.

3.1 General overview of the Analyzer

CHEMIST 100 BE GREEN is a portable industrial analyzer for flue gas and emissions monitoring.

The instrument is equipped with:

- Pneumatic line able to manage up to 3 sensors.
- Intuitive user interface; the instrument could be used even without the instruction manual support.
- Wide and bright graphic display, White / Black (128x128 pixel), thanks to an efficient backlighting.
- Rechargeable 'Li-Ion' battery.
Supplied with the device is power supply with 5V $\overline{---}$, 2A output to charge the internal batteries.
When needed, it is possible to recharge the instrument battery using a power bank, as long as it is equipped with 5 volts output and 1A minimum current.

Main functions:

- Combustion analysis on manual or automatic mode.
- Comes with 15 most used fuel parameters (such as natural gas, LPG, gas oil and fuel oil).
- Memory capable of storing up to 5 full analysis.
- Storing of acquired data and their averaging.
- Generation and visualization of a QR code with the purpose of downloading the data of the acquired measures, having installed the App Seitron "SMARTFLUE LITE MOBILE" which can be downloaded from the AppStore (Apple devices) and from the Google play Store (Android devices).
- It is possible to print on ticket the performed analysis, through Bluetooth[®] / IR (infrared).

Measured values:

- O₂
- CO
- NO
- Primary air temperature
Gas pressure in the piping, pressure in the burning chamber and check of the pressure switches, using the measurement range up to 200hPa.
- Measuring differential pressure
- Pressure measurement of the gas alimentation line
- CO environment measurement (via the internal sensor)
- Draught measurement.

Calculated values:

- Stack leaks
- Combustion efficiency
- CO₂
- NO_x
- Black smoke value memorization, average value calculation (If the instrument version is provided with it)
- Air excess
- Poison index (CO/CO₂ ratio)

Maintenance:

- Sensors can be replaced by shipping the instrument to the service center.
- The instrument requires annual calibration to be carried out at any authorized service center.

Certificate of calibration

The instrument comes with a calibration certificate made according to EN17025 standard requirements.

4.1 Working principle

The gas sample is taken in through the gas probe, by a diaphragm suction pump inside the instrument. The measuring probe has a sliding cone that allows the probe to be inserted in holes with a diameter of 11 mm to 16 mm and to adjust the immersion depth: **it is recommended to have a gas sampling point roughly in the center of the flue/stack**. The gas sample is cleaned of humidity and impurities by a condensation trap. The gas is then analyzed in its components by electrochemical cells. This latter guarantees high precision results in a time interval of up to about 60 minutes during which the instrument can be considered very stable. When measurement is going to take a long time, we suggest auto-zeroing the instrument again and flushing the inside of the pneumatic circuit with clean air.

During the zero calibrating phase, the instrument aspirates clean air from the environment and detects the cells' drifts from zero (20.95% for the O₂ cell), then compares them with the programmed values and automatically compensates them.

4.2 Measurement cells

The instrument makes use of pre-calibrated gas sensors for the measurement of Oxygen (O₂), Carbon Monoxide (CO) and Nitrogen Oxide (NO).

The sensors do not need particular maintenance yet they have to be replaced periodically when exhausted.

If sensors of toxic gases are submitted to concentrations higher than 50% of their measurement range for more than 10 minutes continuously, they can show up to $\pm 2\%$ drift as well as a longer time to return to zero.

In this case, before turning off the analyzer, it is advisable to wait for the measured value be lower than 20ppm by in taking clean air.

Anyway, the instrument is intended to have a cleaning cycle of the pneumatic circuit, which duration depends on what has been set in the menu Configuration→Analysis→Autozero.

Once exhausted, the cells must be replaced by the Seitron assistance center.

According to national standards and fundamental for users complying with ISO 9000, it is advised to send the instrument at a certified Seitron laboratory to be calibrated.

Seitron certifies the accuracy of the measurements only upon a calibration certificate issued by its laboratory or other approved laboratory.

4.3 Fuel types

The device is provided with the technical data of the most common types of fuels stored in its memory.

For more details [see Annex C](#).

4.4 Sample treatment

The gas sample to be analyzed must be delivered to the measuring sensors properly dried and cleaned of solid residues of combustion; actually for this reason it is usually named 'dry analysis'.

For this purpose, on the gas suction probe, is mounted an anti-condensation trap with dust filter.

4.5 Pressure sensor, piezoelectric, temperature compensated

The instrument is internally provided with a piezoresistive differential pressure sensor which can be used for measuring the draft (depressure) in the chimney for differential pressure measurement and possibly for other measurements (pressure of gas in the piping, pressure loss across a filter, etc.).

The measurement range is -100,00 hPa .. +200,00 hPa.

Any potential drift of the sensor are nulled thanks to the autozeroing system.



WARNING

ANY PRESSURE APPLIED TO THE SENSOR GREATER THAN ± 300 hPa MAY CAUSE A PERMANENT DEFORMATION OF THE MEMBRANE, THUS DAMAGING IRREVERSIBLY THE SENSOR ITSELF.

4.6 Suction pump

This diaphragm pump, located inside the instrument, is operated with a DC engine powered by the instrument in order to obtain the optimal suction flow rate of the flue gas for the on-going analysis.

4.7 Draft measurement with sensor automatic autozero

CHEMIST 100 BE GREEN performs the draft measurement.

The sensor Autozero allows to make the zeroing of the sensor and must be done with the gas probe **NOT** inserted in the stack.

4.8 Smoke measurement (if the instrument version provides it)

It is possible to enter the smoke values measured according to the smoke index scale. The instrument will calculate the average and print the results in the analysis report.

The measure must be done with a manual pump for the black smoke measurement, which can be requested as an accessory.

4.9 Temperature measurements

The CHEMIST 100 BE GREEN is equipped for the measurement of the temperature using the gas probe or an optional remote probe Tc-K type.

4.10 Bluetooth® connection (if the instrument version provides it)

The CHEMIST 100 BE GREEN analyzer is internally equipped with a Bluetooth® module, which allows the communication with a remote Bluetooth® printer

The maximum transmission range in open field is 100 meters (Class 1 Bluetooth® module), provided that also the communication companion is equipped with a Class1 Bluetooth® interface.

This solution allows great freedom of movement for the operator who is no longer bound directly to the instrument for acquisition and analysis, with significant advantages for many applications.

4.11 IR connection (if the instrument version provides it)

The CHEMIST 100 BE GREEN analyzer is internally equipped with an infrared light interface which uses the HP-IR protocol, which allows the communication with a remote IR printer.

5.0 COMPONENTS DESCRIPTION

5.1 Instrument interface

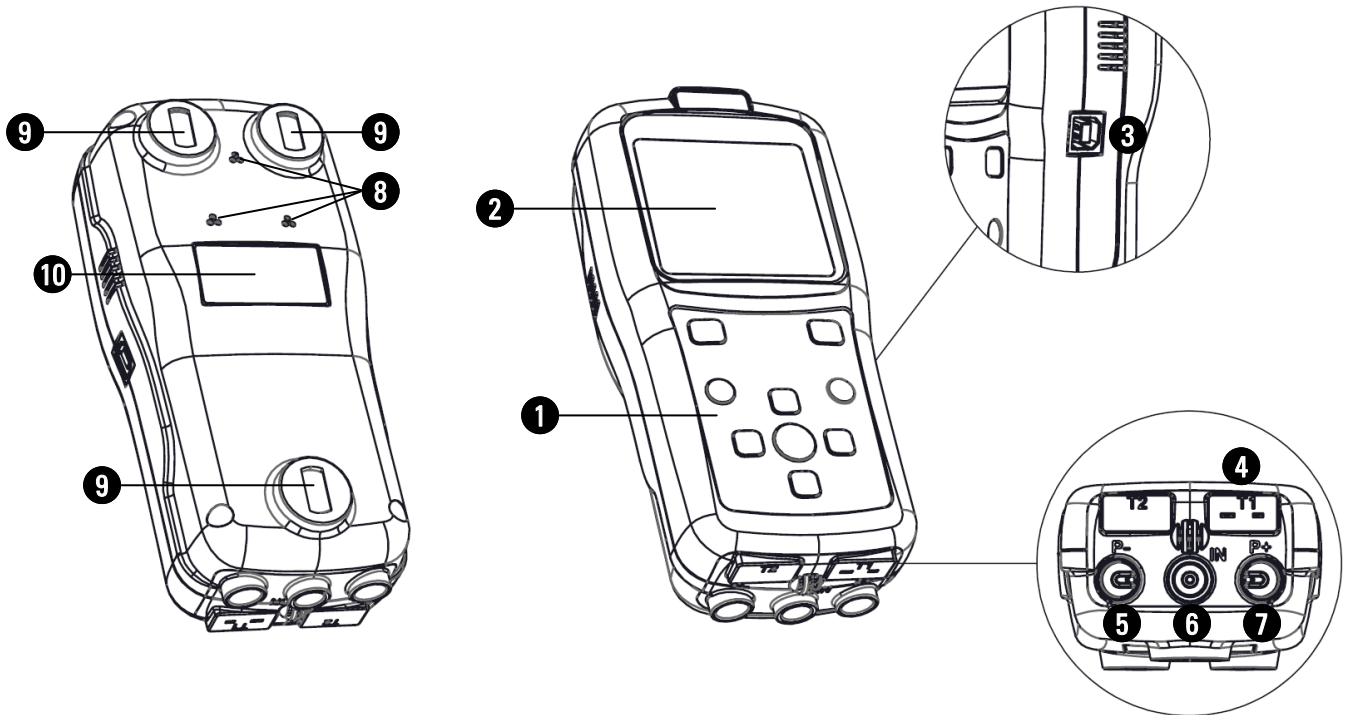

DESCRIPTION:

1 Polyester keyboard with preformed keys and main command functions:

KEYS	FUNCTION
	Activates the context keys shown on the display.
	<ul style="list-style-type: none"> - Turns on and off the instrument. - If pressed briefly, accesses the instrument menu. - If pressed for at least 2 seconds, turns off the instrument.
	Exits the current screen.
	Confirm settings.
	Select and/or Modify.

2 Display

LCD backlit Display, White/Black 128 x 128 pixel with white LEDs.

CAUTION:

If the instrument is exposed to extremely high or extremely low temperatures, the quality of the display may be temporarily impaired. Display appearance may be improved by acting on the contrast key.

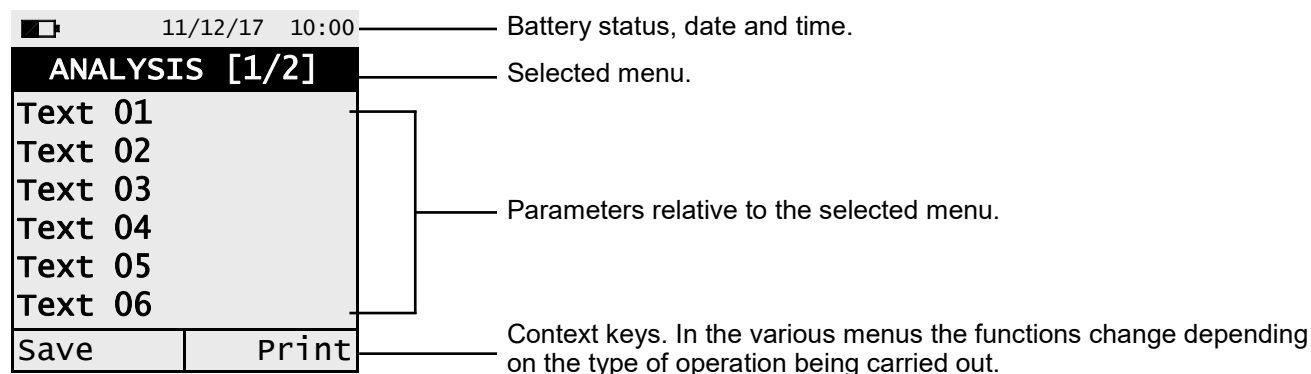

3 B-Type USB connector

Connector to connect the device to a personal computer or to the battery charger.

The device comes with a wall charger with 5V $\overline{=}$, 2A output to charge the internal batteries.

4 'T1' Connector

Used to connect the Tc-K male connector of the gas temperature probe.

5 'P-' pneumatic connector

Negative input (P-) to be used for the connection of the gas aspiration probe; to this input, must be connected the second branch (with the largest pneumatic connection) of the gas probe for the measurement of the draft and the combustion analysis.

6 'IN' pneumatic connector

Input for the connection of the branch of the gas sampling probe with the condensation separating and anti-dust filter assembly.

7 'P+' pneumatic connector

Positive input (P+): used for the pressure measurements values.



Inputs 'P+' and 'P-' are respectively the positive and negative inputs of the internal differential pressure sensor, piezoresistive, temperature compensated; therefore these can be simultaneously used to measure the differential pressure.

8 Gas output

9 Magnets

10 Instrument data label

6.0 TECHNICAL SPECIFICATIONS

6.1 Technical specifications

Power supply:	Li-Ion battery pack with internal protection circuit.
Average life of the battery pack:	500 empty / full charge cycles.
Battery charger:	External 5Vdc 2A battery charger with female A-type USB connector + connection to the device with the same serial communication cable supplied.
Charging time:	5 hours to charge from 0% to 90% (6 hours for 100%). The device can also be charged by connecting it to the PC, the device must be turned off, the charging time depends on the output current from the PC and may be more than 12 hours.
Instrument's operability time:	8 hours of non-stop operation.
<hr/>	
Display:	Graphic white LED backlit White / Black, 128 x 128 pixel
<hr/>	
<u>Connectivity:</u>	
Communication port:	USB connector type B.
Bluetooth® (if provided):	Class 1. Communication distance <100 meters (in open field)
Infrared interface (if provided):	For external printer (optional) using protocol HP-IR.
<hr/>	
Autozero:	Settable (30 .. 600 seconds)
<hr/>	
Gas measurement sensors:	Up to 3 electrochemical sensors
Type of combustible:	15 default preset.
<hr/>	
Self-diagnosis:	Checks all functions and internal sensors and reports any abnormal operation.
Temperature measurement:	Input for thermocouple type K with mignon connector (ASTM E 1684-96) for the temperature measurement.
Room temperature measurement:	Through the internal sensor and/or acquisition through the gas probe positioned in air.
<hr/>	
Internal data memory:	5 complete analyses.
<hr/>	
Suction pump:	1.0 l/min heads at the flue up to 80 hPa.
<hr/>	
<u>Condensate trap:</u>	
Type:	External.
Line filter:	With replaceable cartridge, 99% efficient with 20 um particles.
<hr/>	
Condensing boiler efficiency:	Automatic recognition of the condensing boiler, with calculation and printout of efficiency (>100%) on the LHV (Lower Heating Value).
Environmental gases:	Measurement and separate printout of the ambient CO values.
Draught test:	By using the internal sensor connected to the P- input.
<hr/>	
Operating temperature range:	-5°C .. +45°C
Storage temperature range:	-20°C .. +50°C
Humidity limit:	20% .. 80% RH
Protection rating:	IP42
Air pressure:	Atmospheric
Outer dimensions:	Analyzer: 7 x 6 x 17 cm (L x A x P) Case: 40 x 29 x 12 cm (L x A x P)
Weight:	Analyzer: ~ 0,35 Kg
<hr/>	

Compliant with the European standard EN50379-1 EN50379-2 and EN50379-3.
See the declaration of conformity ([ANNEX D](#)).

6.2 Measurement and Accuracy Ranges

MEASUREMENT	SENSOR	RANGE	RESOLUTION	ACCURACY	RESPONSE TIME T90	
O ₂	Electrochemical sensor	0 .. 21.0% vol	0.1% vol	±0.2% vol	<20 sec.	
CO high H ₂ immunity	Electrochemical sensor	0 .. 4000 ppm	1 ppm	±20 ppm ±5% measured value	0 .. 400 ppm 401 .. 4000 ppm	<30 sec.
NO	Electrochemical sensor	0 .. 2000 ppm	1 ppm	±5 ppm ±5% measured value ±10% measured value	0 .. 100 ppm 101 .. 1000 ppm 1001 .. 2000 ppm	<40 sec.
NO _x	Calculated					
CO ₂	Calculated	0 .. 99.9% vol	0.1% vol			
PJ* (CO/CO ₂ ratio)	Calculated		0.01%			
Air temperature	TcK sensor	-20.0 .. 120.0 °C	0.1 °C	±1 °C	<30 sec.	
Flue gas temperature	TcK sensor	-20.0 .. 800.0 °C	0.1 °C	±1 °C ±1% measured value	0 .. 100 °C 101 .. 800 °C	<30 sec.
Pressure (draught & differential)	Piezoelectric sensor	-100.0 .. 200.0 hPa	0.01 hPa	±1% measured value ±0.02 hPa ±1% measured value	-100.00 .. -2.01 hPa -2.00 .. +2.0 hPa +2.01 .. +200.0 hPa	<10 sec
Differential temperature	Calculated	0 .. 800 °C	0.1 °C			
Air index	Calculated	0.00 .. 9.50	0.01			
Excess air	Calculated	0 .. 850 %	1 %			
Stack loss	Calculated	0.0 .. 100.0 %	0.1 %			
Efficiency	Calculated	0.0 .. 100.0 %	0.1 %			
Efficiency (condensing)	Calculated	0.0 .. 120.0 %	0.1 %			

* The Poison Index ratio (P.I.) is a reliable indicator of a boiler or burner good operation. It only takes a simple flue gas test to determine whether or not a service is needed to fix the system.

7.1 Preliminary operations

Remove the instrument from its packing and check it for damage. Make sure that the content corresponds to the ordered items. If signs of tampering or damage are noticed, notify that to the SEITRON service center or agent immediately and keep the original packing. A label at the rear of the analyzer contains the serial number. This serial number should always be kept in mind when requesting technical assistance, spare parts or clarification on the product or its use. Seitron maintains an updated database for each and every instrument. Before using the instrument for the first time, we recommend you charge the batteries completely.

7.2 WARNING

- Use the instrument with an ambient temperature between -5 and +45°C.

	IF THE INSTRUMENT HAS BEEN KEPT AT VERY LOW TEMPERATURES (BELOW OPERATING TEMPERATURES) WE SUGGEST WAITING A WHILE (1 HOUR) BEFORE SWITCHING IT ON TO HELP THE SYSTEM'S THERMAL BALANCE AND TO PREVENT CONDENSATE FORMING IN THE PNEUMATIC CIRCUIT.
--	--

- Do not extract flue gas samples directly without using a particulate/water trap.
- Do not use the instrument if the filters are clogged or damp.
- Do not exceed sensor overload thresholds.
- When it has finished being used, before turning the instrument off, remove the probe and let it aspirate ambient clean air for at least 30 seconds to purge the pneumatic path from all traces of gas.
- Before putting the measuring probe back in its case after use, make sure it is has cooled down enough and there is no condensation in the tube. It might be necessary to periodically disconnect the filter and the condensate separator and blow compressed air inside the tube to eliminate all residues.
- Remember to have the instrument checked and calibrated once a year in order to comply with the existing standards.

7.3 Analyzer power supply

The instrument contains an high-capacity Li-Ion rechargeable battery. The battery feeds the instrument, built-in printer and any other probes or remote devices that may be connected. The instrument runs for approximately 18 hours if the printer is not used. Should the battery be too low to effect the necessary measurements, the instrument can be hooked up to the mains via the power pack provided, allowing operations (and analysis) to proceed. The battery will be recharged whilst the instrument is being used. The battery charging cycle takes up to 3 hours for a complete charge and finishes automatically.

ATTENTION: If the instrument is not going to be used for a long time we suggest recharging it at least once every 4 months.

7.3.1 Internal battery charge level

The display constantly shows the internal battery charge level shown with the symbol in the upper left corner of the display.

7.3.2 Use with external power pack

SYMBOL	BATTERY CHARGE LEVEL
	100%
	80%
	60%
	40%
	20%
	It's advisable to recharge the battery.
	Dead battery Recharge the battery - The instrument may not function correctly.

	THE INSTRUMENT IS SHIPPED WITH THE 30% OF BATTERY LIFE SO IT IS ADVISABLE TO CHARGE IT COMPLETELY BEFORE USE, TAKING 3 HOURS.
	IT IS ADVISABLE TO CHARGE THE BATTERY AT AN AMBIENT TEMPERATURE RANGING BETWEEN 50°F AND 86°F (10°C AND 30°C).

The instrument can work with the batteries fully discharged by connecting the external power pack provided.



**THE POWER SUPPLY/BATTERY CHARGER IS A SWITCHING TYPE ONE.
THE APPLICABLE INPUT VOLTAGE RANGES BETWEEN 90Vac AND 264Vac.
INPUT FREQUENCY: 50-60Hz.
THE LOW VOLTAGE OUTPUT IS 5 VOLT WITH AN OUTPUT CURRENT GREATER THAN 1.5A.**

LOW VOLTAGE POWER CONNECTOR: A-TYPE USB CONNECTOR + CONNECTION CABLE WITH B-TYPE PLUG.

7.4 QR code generation

The instrument offers the possibility to generate and visualize on the display a QR code with the purpose to download the data of the acquired measures, activating the interactive function "Print" visible on the display in the menu analysis and/or memory, having installed the Seitron App "SMARTFLUE LITE MOBILE" downloadable from the AppStore.

Minimum requirements for the App installation "SMARTFLUE LITE MOBILE"

Operative systems: Android from version 4.1
 Apple (iOS)



THE INSTRUMENT WILL GENERATE THE QR CODE ONLY IF ON THE DISPLAY THE INTERACTIVE FUNCTION "PRINT" IS SHOWN, PRIOR CORRECT SETTING OF THE PARAMETER "CONFIGURATION→PRINT".

7.5 Connection diagram

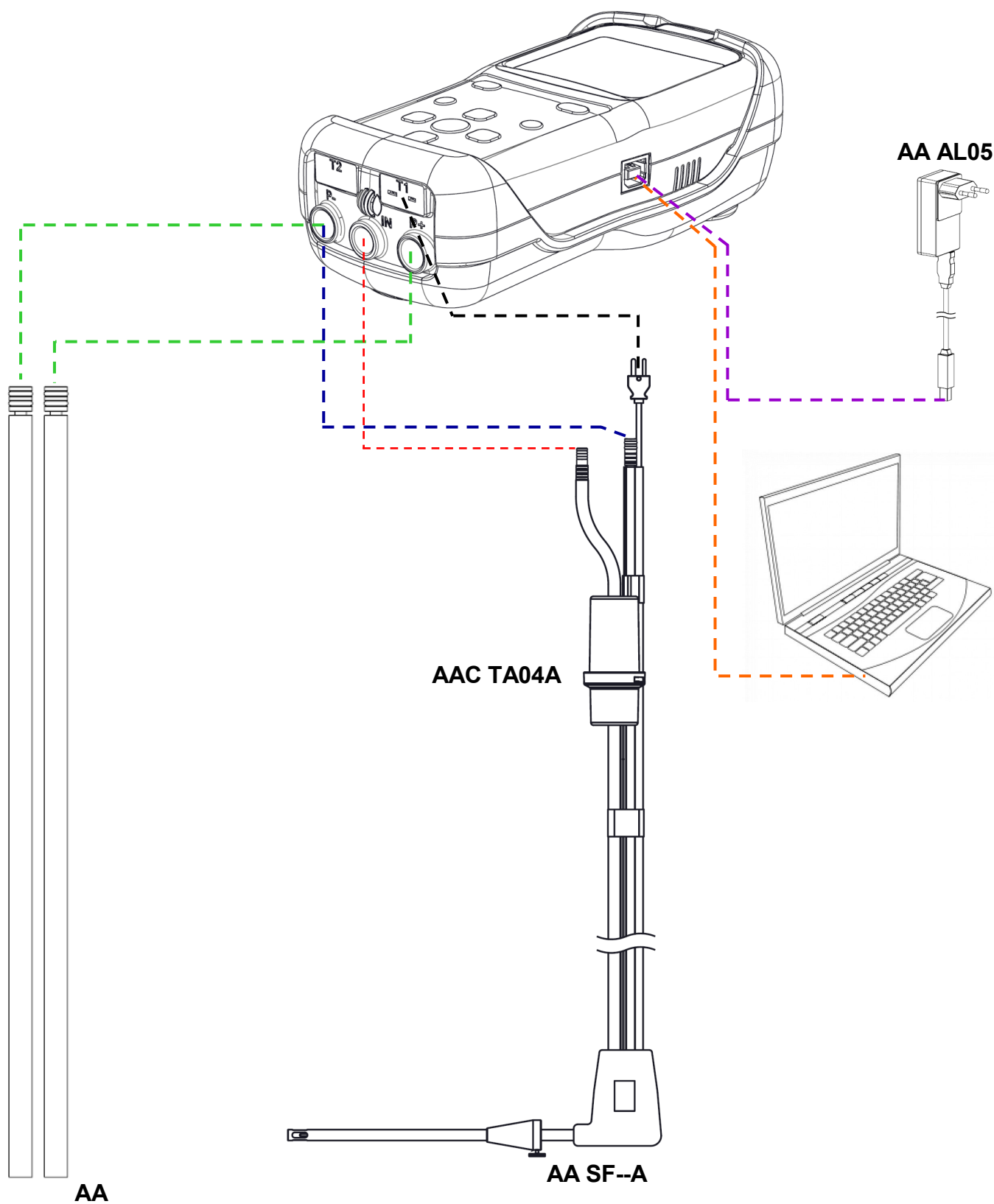

8.1 COMBUSTION ANALYSIS

To perform complete flue gas analysis, follow the instructions below.



SOME IMPORTANT WARNINGS TO CONSIDER DURING THE COMBUSTION ANALYSIS ARE LISTED BELOW:

FOR A CORRECT ANALYSIS NO AIR MUST FLOW INTO THE PIPE FROM OUTSIDE DUE TO A BAD TIGHTENING OF THE CONE OR A LEAK IN THE PIPELINE.

THE GAS PIPE MUST BE CHECKED IN ORDER TO AVOID ANY LEAKAGES OR OBSTRUCTIONS ALONG THE LINE. THE CONNECTORS OF THE GAS SAMPLING PROBE AND OF THE CONDENSATE FILTER MUST BE WELL CONNECTED TO THE INSTRUMENT. KEEP THE CONDENSATE TRAP IN THE VERTICAL POSITION DURING THE ANALYSIS; A WRONG POSITIONING MAY CAUSE CONDENSATE INFILTRATIONS IN THE INSTRUMENT AND THUS DAMAGE THE SENSORS.

AFTER EACH ANALYSIS, CHECK FOR ANY PRESENCE OF WATER IN THE CONDENSATE COLLECTION BOWL AND ELIMINATE IT, IF ANY. PUT THE PROBE BACK IN THE CASE ONLY AFTER YOU HAVE ELIMINATED THE CONDENSATION FROM THE TUBE AND THE EXPANSION TANK (SEE CHAPTER 'MAINTENANCE'). REPLACE THE FINE DUST FILTER IF IT IS VISIBLY DIRTY OR WET (SEE CHAPTER 'MAINTENANCE'). DO NOT PERFORM ANY MEASUREMENT WHEN THE FILTER IS REMOVED OR DIRTY IN ORDER TO AVOID ANY RISK OF IRREVERSIBLE DAMAGES ON SENSORS. DO NOT PERFORM ANY MEASUREMENT WHEN THE FILTER IS REMOVED OR DIRTY IN ORDER TO AVOID ANY RISK OF IRREVERSIBLE DAMAGES ON SENSORS.

CON FILTRO SPORCO PER NON RISCHIARE UN DANNEGGIAMENTO IRREVERSIBILE DEI SENSORI.

8.1.1 Switching on the instrument and auto-calibration



BEFORE TURNING ON THE INSTRUMENT:

- **CONNECT THE GAS SAMPLING PROBE TO THE INSTRUMENT.**
- **STORING OF THE AMBIENT TEMPERATURE: UPON COMPLETION OF THE AUTOZERO IN FRESH OUTDOOR AIR, PRESS THE “KEEP” BUTTON TO STORE THE OUTSIDE TEMPERATURE BEING USED FOR PRIMARY AIR. IF THE Tc-K CONNECTOR IS NOT PLUGGED IN, THE TEMPERATURE WILL NOT BE ACQUIRED.**

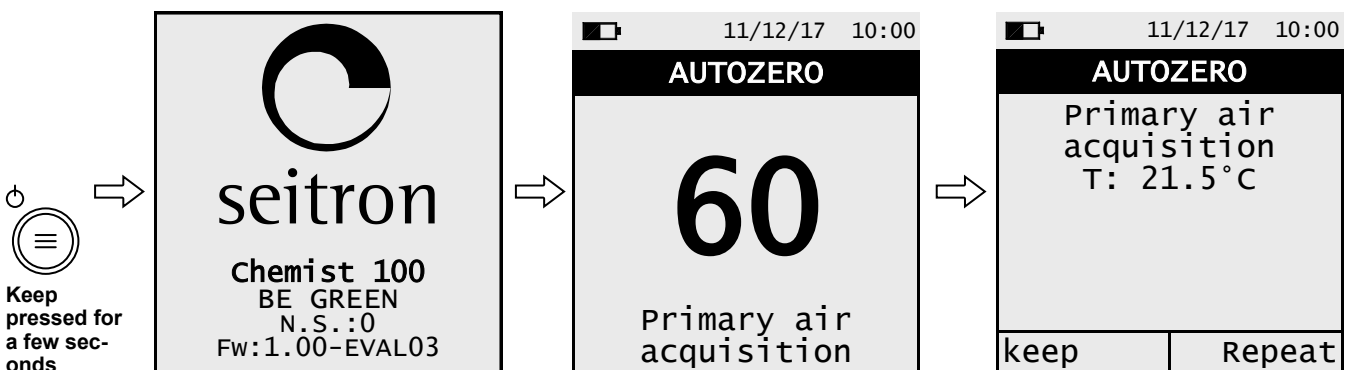

When the autozero phase is complete, push the key related to the interactive function “ **Keep** ”, to proceed with the combustion analysis or push the key related to the interactive function “ **Repeat** ”, to repeat the autozero phase.

8.1.2 Preliminary operations

Following are reported the parameters to set before performing the combustion analysis:

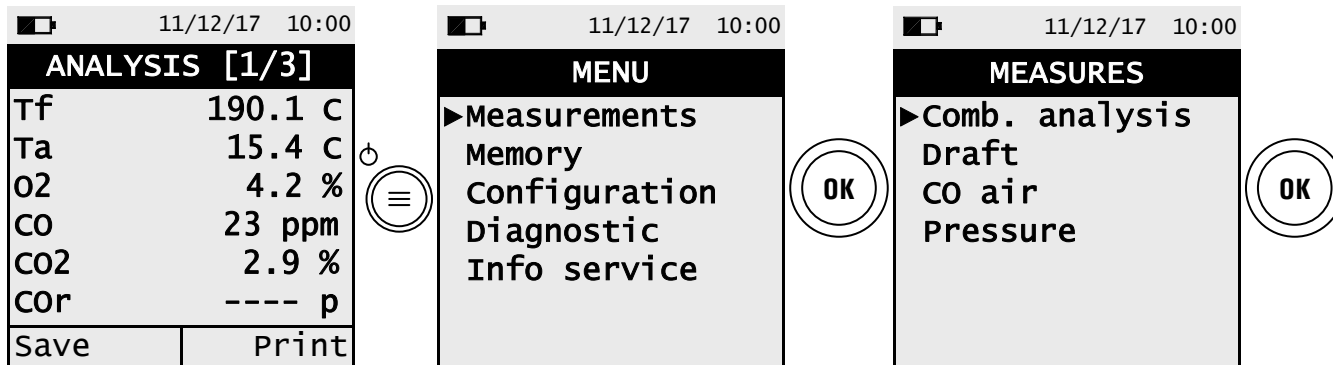

BEFORE PERFORMING THE COMBUSTION ANALYSIS, SET THE NECESSARY PARAMETERS ([SEE CHAPTER 10.2](#)).

8.1.3 Inserting the probe inside the stack

When the autozero is over, insert in the stack the gas sample probe, previously connected to the instrument. In order for the probe to be inserted at the right point within the stack, its distance from the boiler has to be twice the diameter of the stack pipe itself or, if this is not possible, must comply with the boiler manufacturer's instructions.

In order to position the probe correctly drill a 13/16 mm hole in the manifold (unless already present), and screwing in the positioning cone provided with the probe - so no air is drawn from the outside during sampling.

The screw on the cone allows the probe to be stopped at the right measuring depth - this usually corresponds to the center of the flue pipe. For greater positioning accuracy, the user may insert the probe gradually into the pipe until the highest temperature is read.

The exhaust pipe must be inspected before performing the test, in order to ensure that no constrictions or losses are present in the piping or stack.

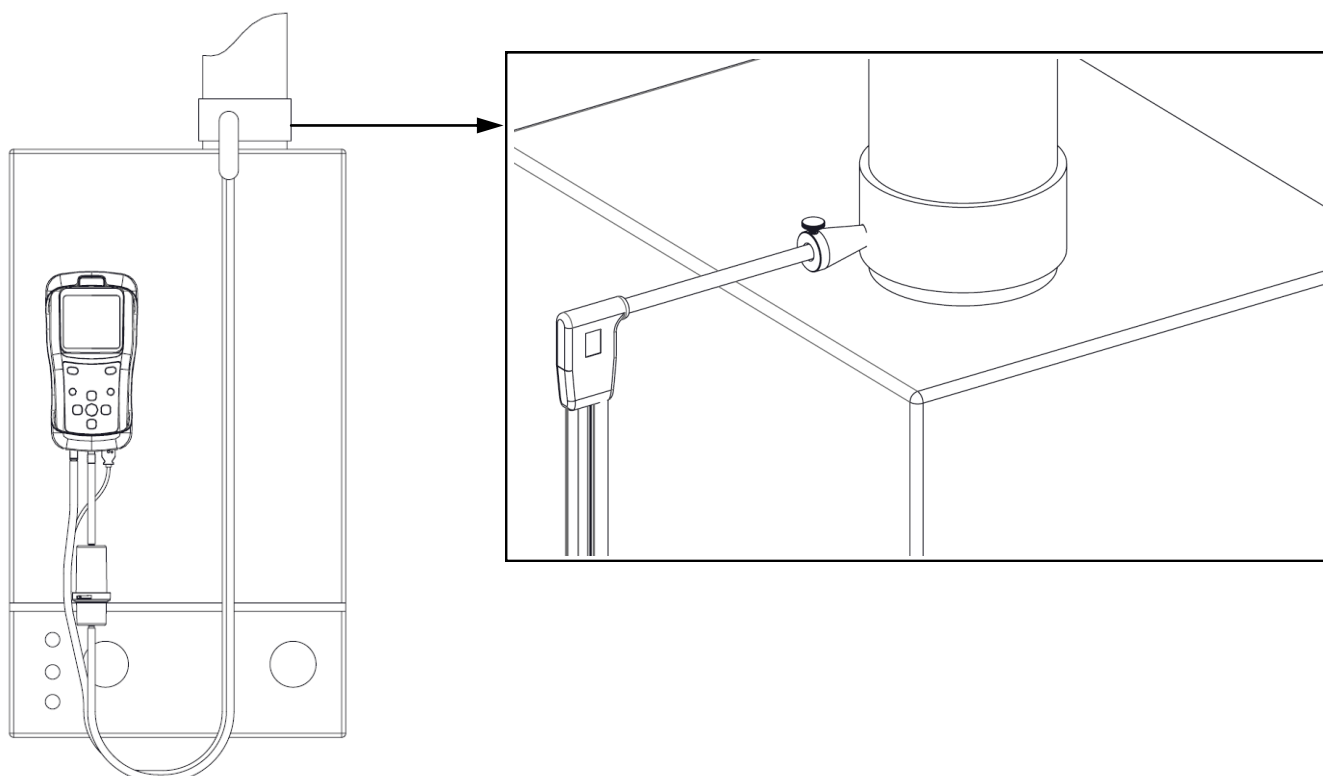

8.1.4 Performing the combustion analysis - Manual mode

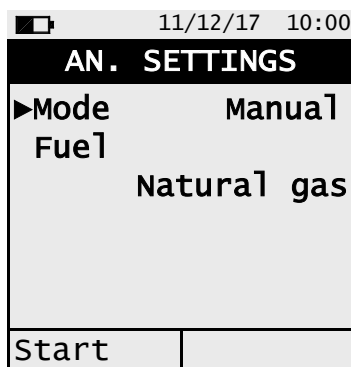

start

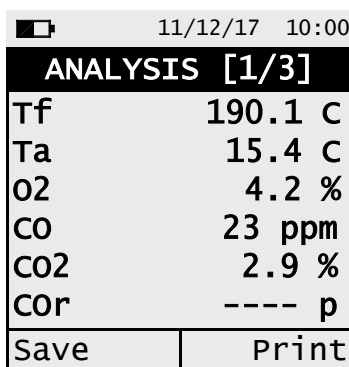

Print

Save

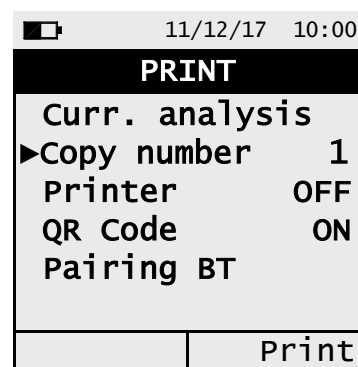

Print

IN THIS SCREEN IT IS POSSIBLE TO MODIFY THE NUMBER OF THE MEMORY IN WHICH THE CURRENT ANALYSIS IS BEING SAVED.
([SEE CHAPTER 11.0](#))

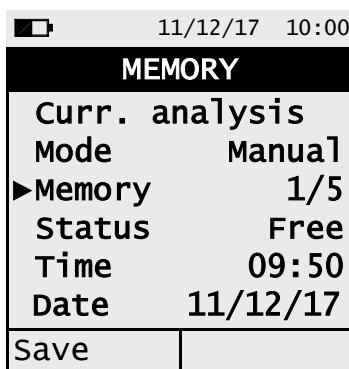

Save

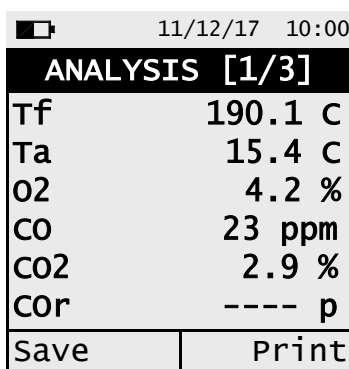

8.1.5 Performing the combustion analysis - Auto Mode

11/12/17 10:00	
AN. SETTINGS	
►Modo	Auto
Fuel	Natural gas
Interval	7 s
Memory	1/5
Start	

Start

11/12/17 10:00	
ANALYSIS [1/3]	
Tf	190.1 C
Ta	15.4 C
O2	4.2 %
CO	23 ppm
CO2	2.9 %
CO _r	---- p
Pause	1/3 7

Automatically stores the first sample when the interval time is over.

11/12/17 10:00	
ANALYSIS [1/3]	
Tf	190.1 C
Ta	15.4 C
O2	4.2 %
CO	23 ppm
CO2	2.9 %
CO _r	---- p
Pause	2/3 7

Automatically stores the second sample when the interval time is over.

11/12/17 10:00	
ANALYSIS [1/3]	
Tf	190.1 C
Ta	15.4 C
O2	4.2 %
CO	23 ppm
CO2	2.9 %
CO _r	---- p
Pause	3/3 7

Automatically stores the third sample when the interval time is over.

11/12/17 10:00	
AVERAGE [1/3]	
O2	4.2 %
CO	23 ppm
CO2	2.9 %
Tf	190.1 C
Ta	15.4 C
Es	91.4 %
	Print

Print



- SCAN THE QR CODE WITH THE SEITRON APP "SMARTFLUE LITE MOBILE", IN ORDER TO DOWNLOAD THE ACQUIRED DATA. THE VISUALIZED QR CODE IS REFERRING ONLY TO THE AVERAGE OF THE PERFORMED ANALYSIS.
- IF IT IS NEEDED TO PRINT THE AVERAGE ANALYSES AND ADDITIONAL MEASURES TICKET, ENABLE THE PRINTER IN THE MENU "CONFIGURATION→PRINT".
- IF IT IS DESIRED TO PRINT ON TICKET THE COMPLETE ANALYSIS AND THE PERFORMED MEASURES, ENTER THE "MEMORY" MENU, SELECT THE RELATED MEMORY NUMBER AND PUSH THE INTERACTIVE FUNCTION KEY "PRINT".
- TO DOWNLOAD THE SINGLE ANALYSIS DATA, IT'S NECESSARY TO ENTER THE "MEMORY" MENU, SELECT THE MEMORY NUMBER USED TO SAVE THE ANALYSES AND THE MEASURES THEN SELECT ONE AT A TIME THE SINGLE ROWS.
(SEE CHAPTER 11.0).

Additional Information

INTERACTIVE OPERATION	DESCRIPTION
<div style="border: 1px solid black; padding: 5px; display: inline-block;">Pause</div>	By pushing the button related to this interactive function, the instrument stops the current analysis when the set time interval is over. This condition is shown with the symbol " <div style="border: 1px solid black; padding: 2px; display: inline-block;">Paused</div> ".
<div style="border: 1px solid black; padding: 5px; display: inline-block;">Keep</div>	When the "Paused" phase is over, the interactive function "Keep" is shown. By activating this function the acquired sample is memorized and the instrument continues with the acquisition of the next sample.



BY PRESSING AT ANY MOMENT THE  BUTTON, IT IS POSSIBLE TO INTERRUPT THE COMBUSTION ANALYSIS AND GO BACK TO THE MAIN SCREEN.

8.1.6 End of Analysis

- At the end of the analysis, carefully remove the sample probe and remote air temperature probe, if used, from their relative ducts, taking care not to get burnt.
- Switch off the instrument.

Then, proceed to turn off the instrument.

The instrument execute a cleaning cycle, according to what's set in the menu "Configuration→Analysis→Autozero→Purging", during which the pump sucks clean air until reducing the concentration of CO and/or NO. The instrument automatically turns off within max. 10 minutes.

Note: It is always advisable to purge the instrument with clean air for at least 5 - 10 minutes before turning it off.



WHEN THE GAS SAMPLING PROBE IS TAKEN OUT OF THE STACK, THE FORMATION OF SOME CONDENSATION IN THE PROBE TUBE AND IN THE ANTI-CONDENSATION TRAP MAY OCCUR.

IT IS ADVISED TO ACCURATELY CLEAN EVERY PART BEFORE PUTTING AWAY THE PROBE AND THE ANTI-CONDENSATION TRAP IN THE CASE.

IN ORDER NOT TO DAMAGE THE CASE MAKE SURE THAT THE METALLIC PROBE PIPE IS AT AN INFERIOR TEMPERATURE THAN 60°C.

Gas sampling probe cleaning

- When you finish using the sample probe clean it thoroughly as described below before returning it to its case:
 - Disconnect the sample probe from the instrument and from the water trap (Fig. a-b) then blow a jet of clean air into the hose of the probe (refer to Fig. b) to remove any residual condensate that may have formed within.

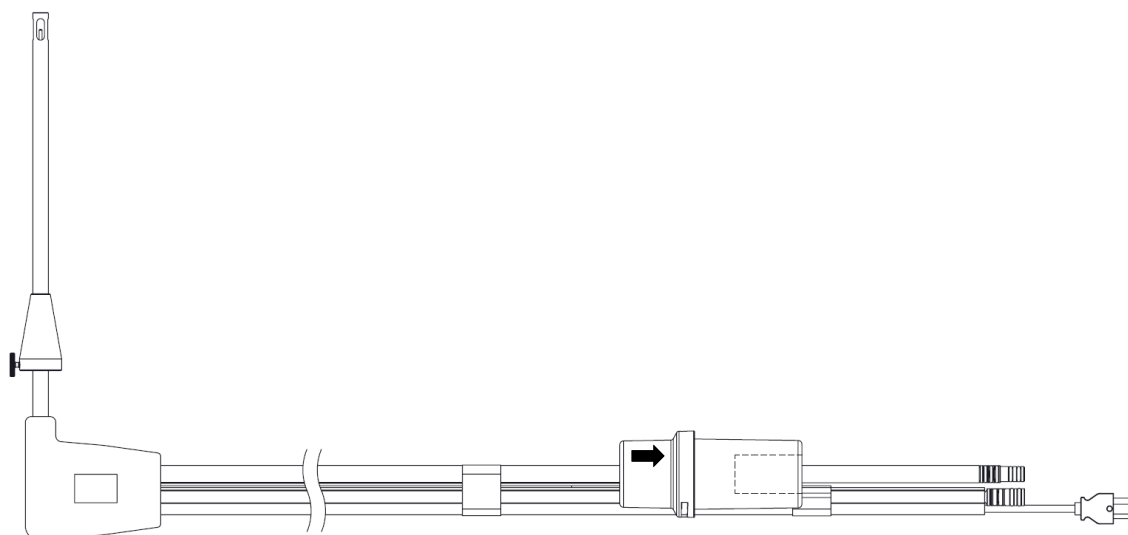

Fig. a

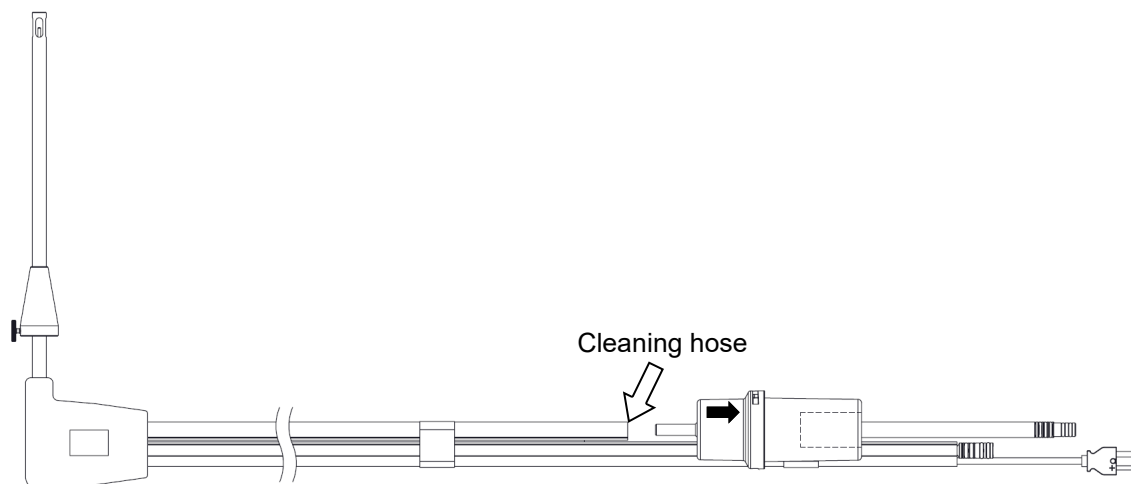
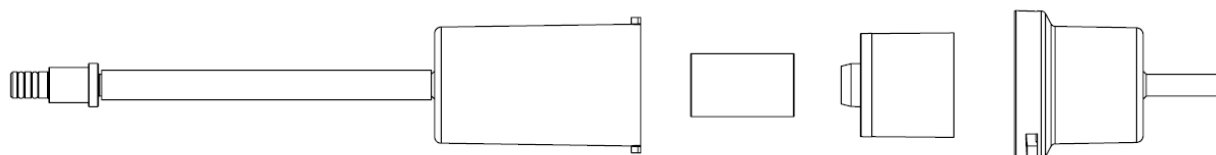

Fig. b

Maintaining the water trap / filter unit

To remove the water trap, just rotate the cover and unhook the filter holder body; remove the internal cup and then replace the filter (see figure on the side).

Clean all the filter parts using water only, dry the components and reassemble the filter.



Replacing the particulate filter

If the particulate filter appears black, especially on the inner surface (see next example), it has to be replaced immediately, in order for the gas flow not to be obstructed.

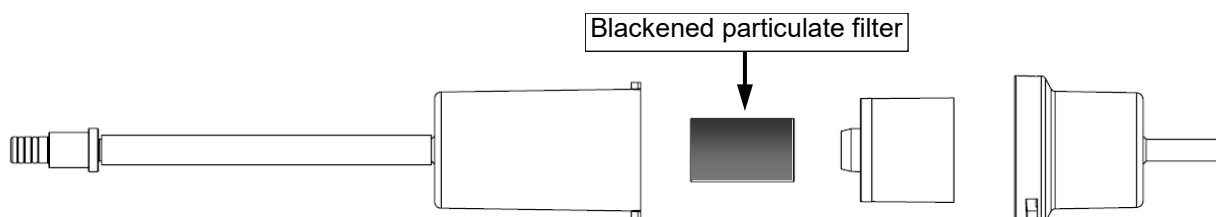

9.1 Parameter menu

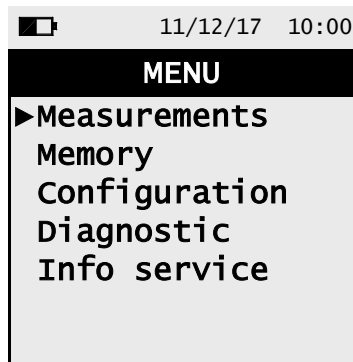

KEY	FUNCTION
	Returns to the previous screen.
	Selects the available parameters.
	Enters in the selected parameter setting.

PARAMETER	DESCRIPTION
Measurements	Through this menu, it is possible to perform the combustion analysis, draft, CO air and pressure measurements. SEE CHAPTER 10.0
Memory	This parameter can set the number of the memory on which record the combustion analysis, the draft measurement, ecc. Moreover, it shows the status (Full or Free) and the details (time and date) of the selected memory number (if the memory position is occupied by some data). It can also visualize, print or delete the memorized data and the additional measures. SEE CHAPTER 11.0
Configuration	The user can set the different reference parameters of the instrument. SEE CHAPTER 12.0
Diagnostic	The user can check any anomalies on the instrument. SEE CHAPTER 13.0
Info service	Shows the information about the status of the instrument. SEE CHAPTER 14.0

10.1 Menu→Measures

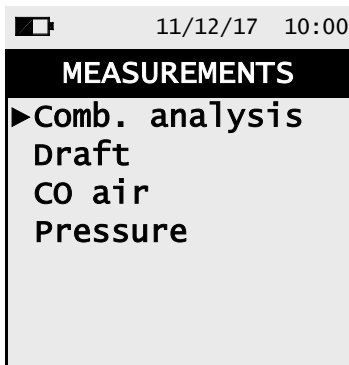

KEY	FUNCTION
	Returns to the previous screen.
	Selects the available parameters.
	Enters in the selected parameter setting.

PARAMETER	DESCRIPTION
Comb. analysis	The user, with this menu, can set the different reference parameters of the instrument to perform the combustion analysis. SEE CHAPTER 10.2
Draft	The DRAFT menu allows to perform the draft measurement of the stack. Being a depression, the draft has to be measured using the negative input P- . The correct values for a natural draft boiler are therefore positive by definition. Afterwards the user can acquire the value displayed in order to add it to the running analysis measurements or, alternatively, print the relevant paper print-out and/or QR code generation through the 'PRINT' menu. NOTE: The measurement may not be accurate due to condensation inside the gas probe. Should you notice an inaccurate or unstable reading on the instrument, it is advisable to disconnect the gas probe from the instrument itself, and purge pipes by blowing with a compressor. In order to be sure there is no humidity, it is suggested to perform the measurement by means of the transparent rubber pipe supplied on issue. SEE CHAPTER 10.3
CO air	This type of analysis lets the user measure the CO value present in the environment, with the scope of checking the personal safety conditions of a specific working environment. The instrument leaves our factory with the following preset threshold values: COmax: 35 ppm Recommended exposure limit (REL) stipulated by the National Institute for Occupational Safety and Health (NIOSH), equivalent to 40 mg/m ³ and calculated as an 8-hour Time-Weighted Average (TWA).  It is compulsory to perform the autozero in the clean air, so that the ambient CO measurement is correct. It is advisable to turn on the instrument and wait for the autozero completion outside the area where the test is being performed. SEE CHAPTER 10.4
Pressure	Through the use of the external flexible pipe made in RAUCLAIR (supplied) to measure a pressure value within the range stated in the technical features (connect the pipe to P+ input). SEE CHAPTER 10.5

10.2 Menu→Measurements→Comb. analysis

11/12/17 10:00	
AN. SETTINGS	
▶Mode	Auto
Fuel	Natural gas
Interval	7 s
Memory	1/5
Start	

KEY	FUNCTION
	Activate the context keys shown on the display.
	Returns to the previous screen.
	Selects the available parameters.
	Enters the selected parameter and confirms the choice made.

INTERACTIVE OPERATION	FUNCTION
	Starts the analysis with the selected mode

PARAMETER	DESCRIPTION
Mode	<p>This menu allows the user to choose among 2 different analysis modes: Manual or Auto</p> <p>Manual: In manual mode, the combustion analysis is performed manually by prior setting the 'Fuel' parameter. Then, the manual analysis can start but waiting, at the beginning, at least two minutes that the shown values are stable; at this moment it is possible to proceed with the memorization or directly to print depending on the setting made.</p> <p>In this mode it is possible to print or save just one combustion analysis containing all the data necessary to fill in the booklet of the system or plant.</p> <p>Auto: In this mode the instrument performs 3 different measures divided by a time gap defined by the user using the sub parameter 'interval'. Moreover, it is possible to select the memory in which is needed to store the analysis and set the used fuel.</p> <p>In all modes, the data displayed regarding the pollutants CO / NO / NO_x can be translated into normalized values (with reference to the concentration of O₂ previously set in "configuration => analysis" menu).</p>
Fuel	Allows the choice of the fuel to be used in analysis phase. This data can be changed not only in this menu, but also in configuration menu.
Interval	ONLY IN 'AUTO MODE'. Sets the time interval for the sample acquisition with a value variable from 1 to 900 seconds.
Memory	ONLY IN 'AUTO MODE'. Allows to select the memory number where to save the analysis. If the memory is full it is possible to choose whether to overwrite the values of the analysis formerly acquired.



TO PERFORM THE COMBUSTION ANALYSIS REFERE TO [CHAPTER 8.0](#)

10.3 Menu→Measures→Draft

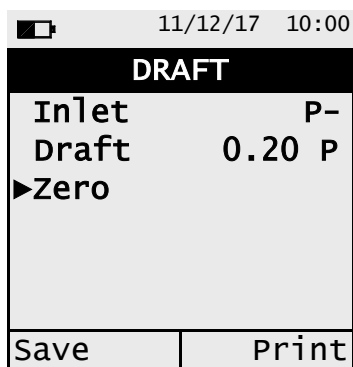

KEY	FUNCTION
	Activate the context keys shown on the display.
	Runs the auto zero of the pressure sensor.
	Select the available parameters and in modification phase sets the value of the external temperature.
	Returns to the previous screen.

INTERACTIVE OPERATION	FUNCTION
Save	Saves in memory the value of the measured draft.
Print	According with the related setting, it is possible to print or visualize the QR code.



To carry out the draft measurement proceed as follows:

- Connect the probe pressure output with the P- inlet of the instrument.
- Perform the autozero of the pressure sensor (after at least 10 minutes after turning on the instrument and immediately before performing the test).
- Insert the tip of the probe in the stack.

Example:

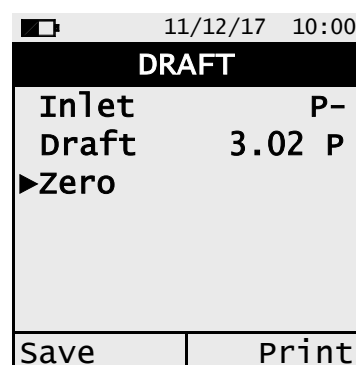
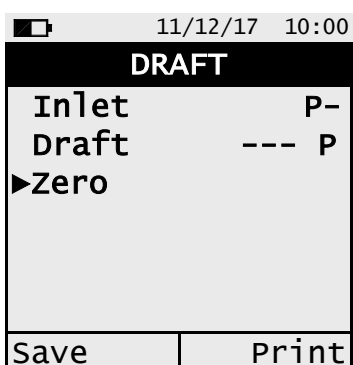

10.4 Menu→Measures→CO air

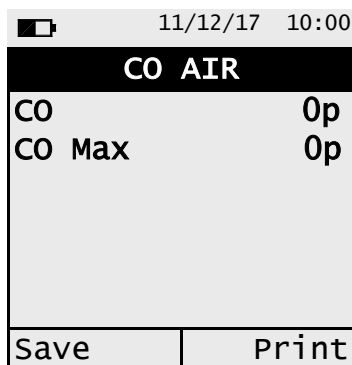

KEY	FUNCTION
	Activate the context keys shown on the display.
	Returns to the previous screen.

INTERACTIVE OPERATION	FUNCTION
Save	Saves in memory the value of the detected CO air.
Print	Prints or shows, depending on the set option in the proper menu, the QR code.



It is compulsory to perform the autozero in the clean air, so that the ambient CO measurement is correct. It is advisable to turn on the instrument and wait for the autozero completion outside the area where the test is being performed.

Example:

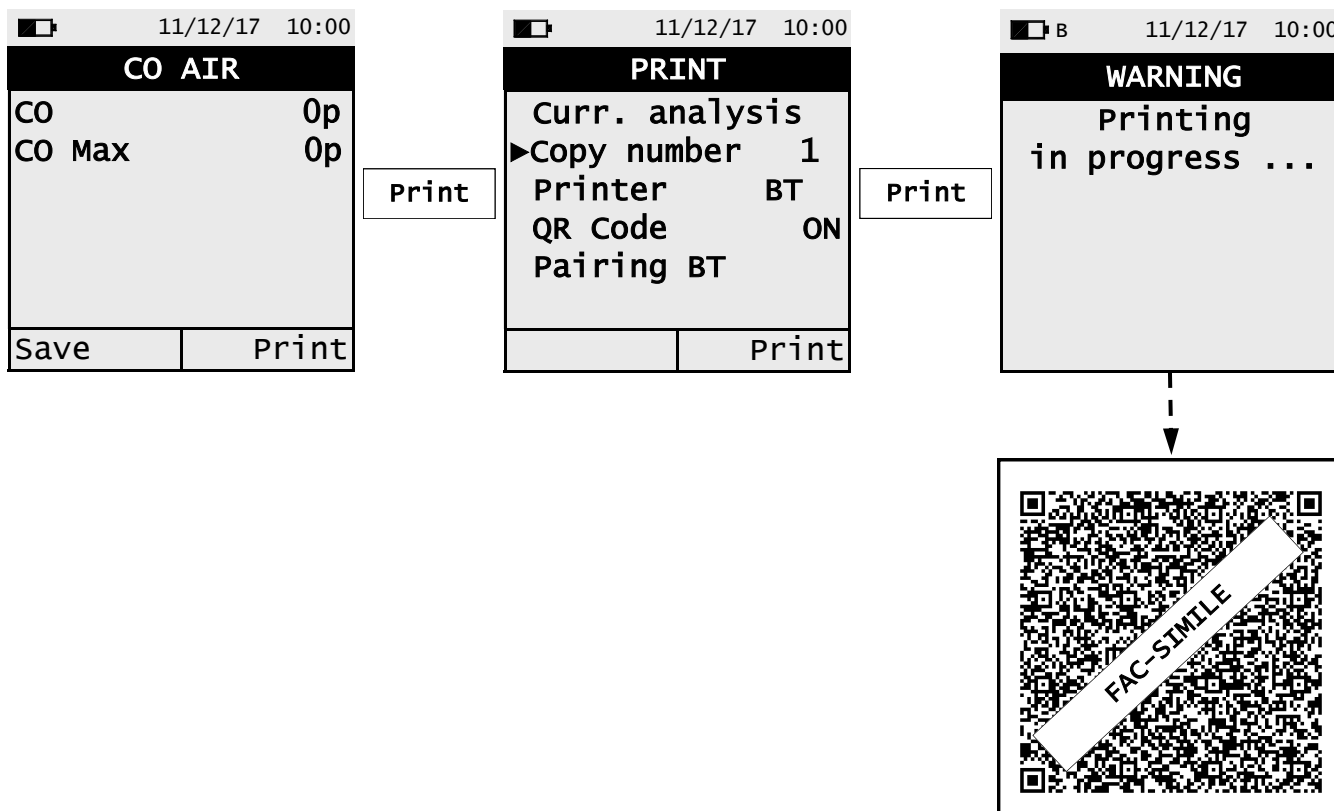

10.5 Menu→Measurements→Pressure

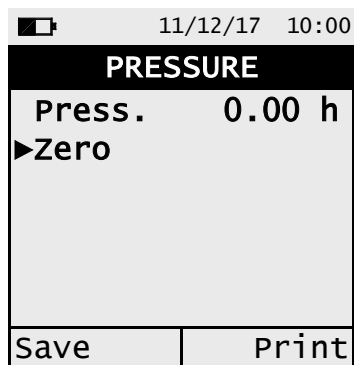

KEY	FUNCTION
	Activate the context keys shown on the display.
	Perform the zero acquisition of the pressure sensor.
	Returns to the previous screen.

INTERACTIVE OPERATION	FUNCTION
Save	Stores in memory the value of the detected pressure.
Print	According to the setting in the related menu, it is possible to print or visualize the QR code.

Example:

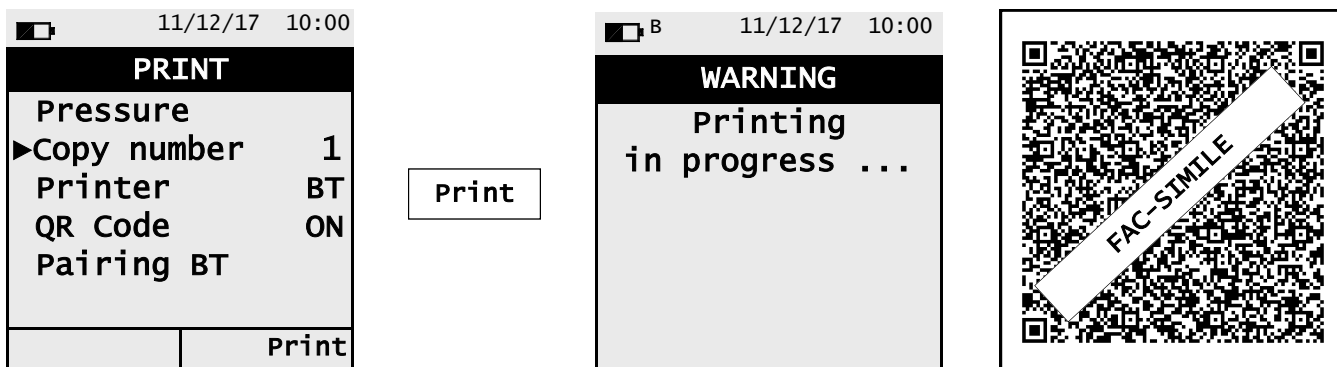
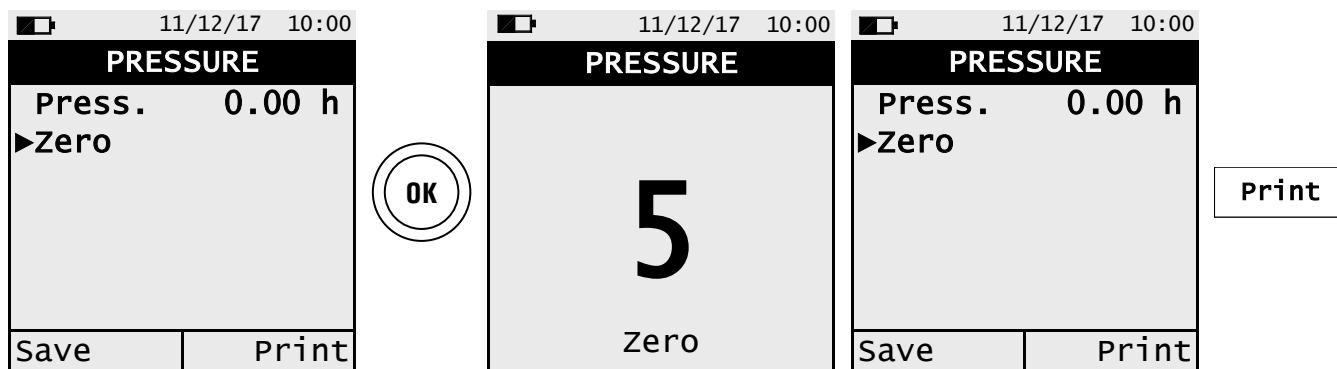

11.1 Menu→Memory

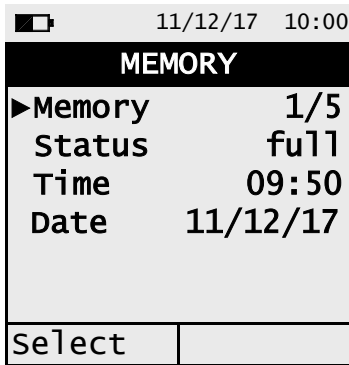

KEY	FUNCTION
	Activate the context keys shown on the display.
	Modifies the memory number and then confirms the changed setting. When selecting the analysis, shows the detail of the evidenced analysis.
 	Selects the available parameters.
	Returns to the previous screen. In modification mode, cancels the setting made.

INTERACTIVE OPERATION	DESCRIPTION
Select	Shows the list of measures within the selected memory number.
Delete	Deletes the entire contents of the selected memory.
Print	Prints the ticket or shows the QR code of the selected memory number.

1. Set memory detail

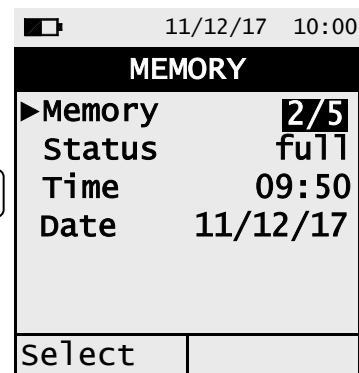
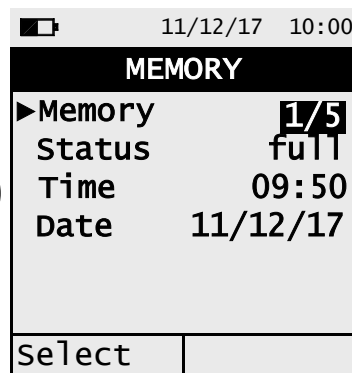
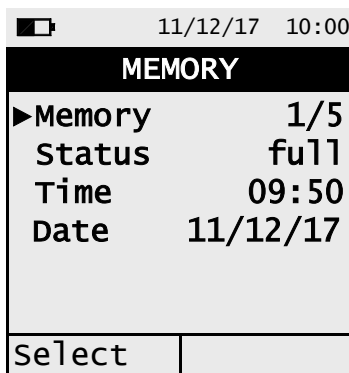

2. Visualization of the memory content

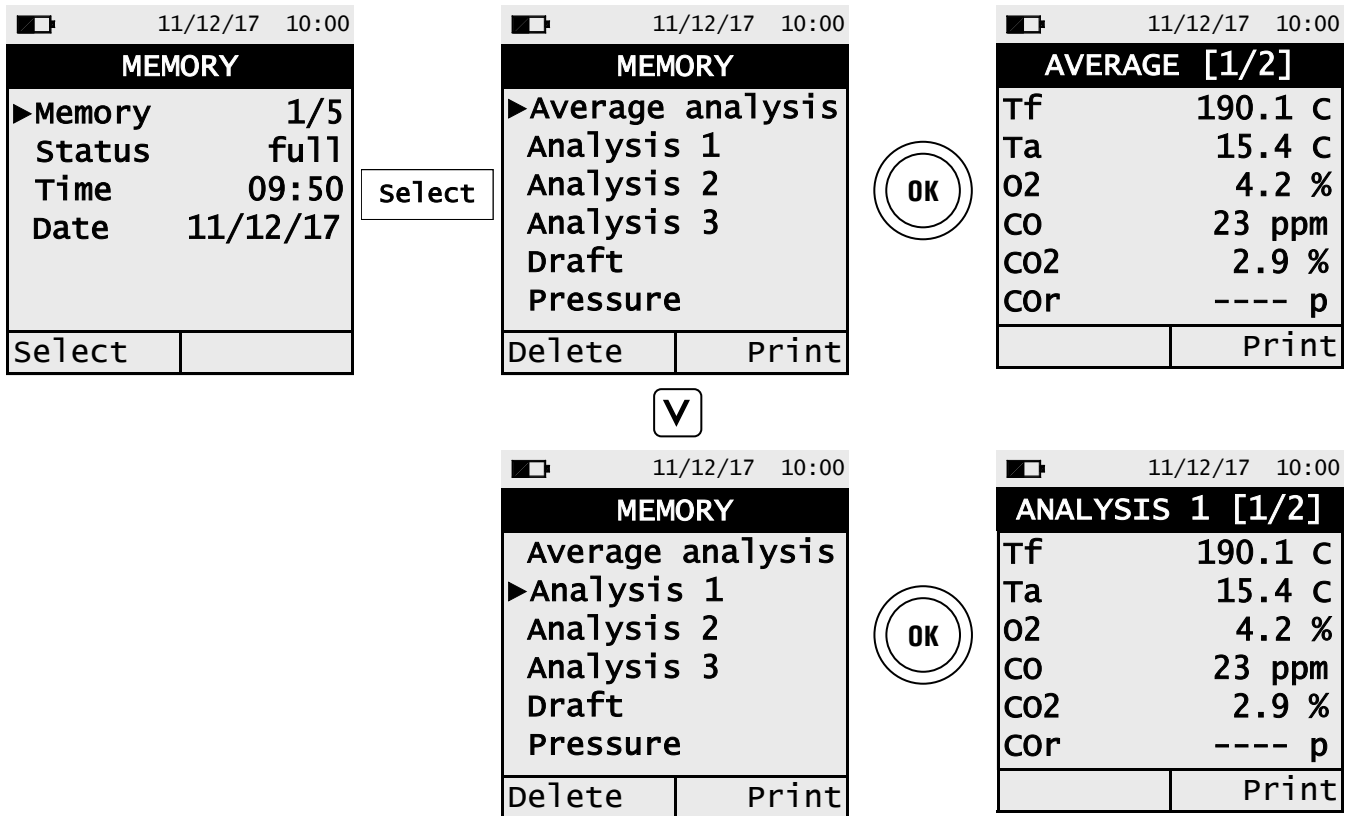

3. Print ticket detail of the entire selected memory

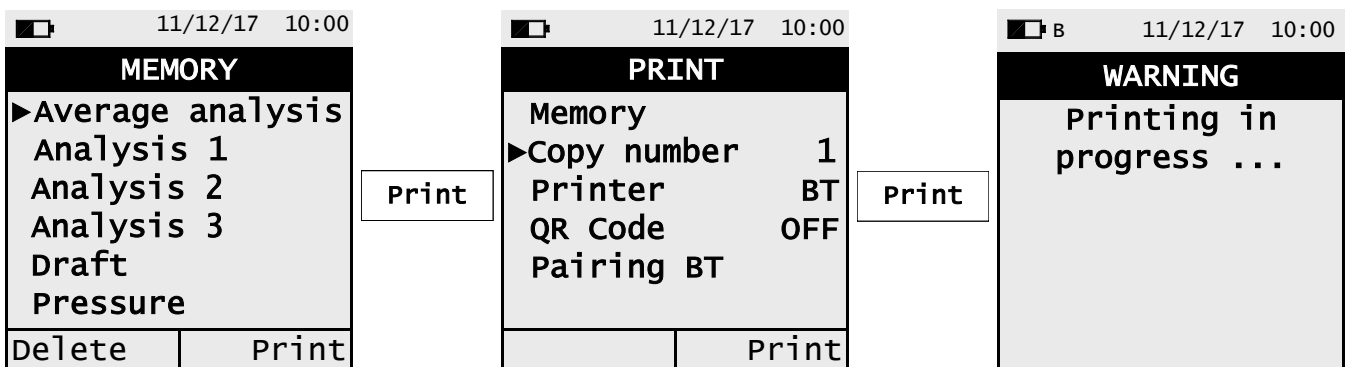

4. Print ticket detail of the single analysis / measure

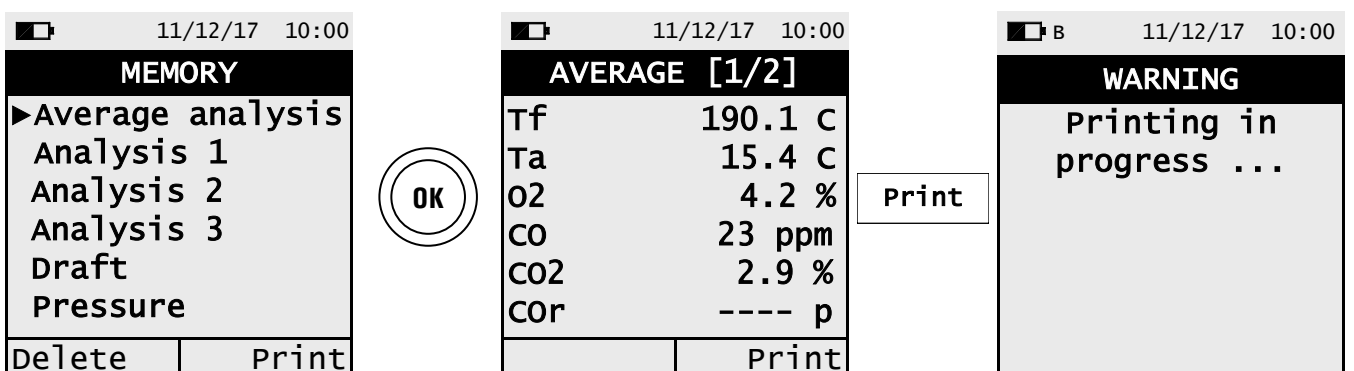

5. Detail of QR code generation to download the average analysis data and the additional measures.

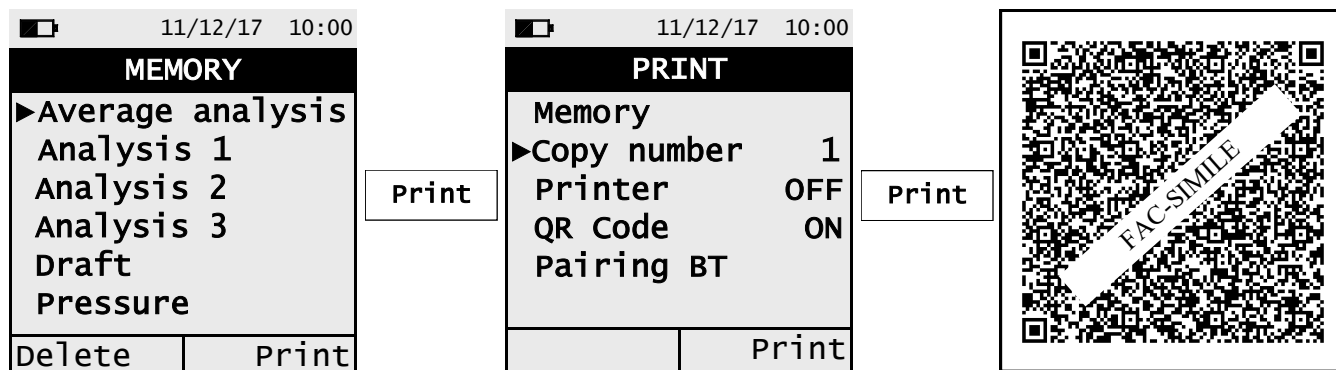

6. Detail of QR code generation to download the data of each single analysis / measure

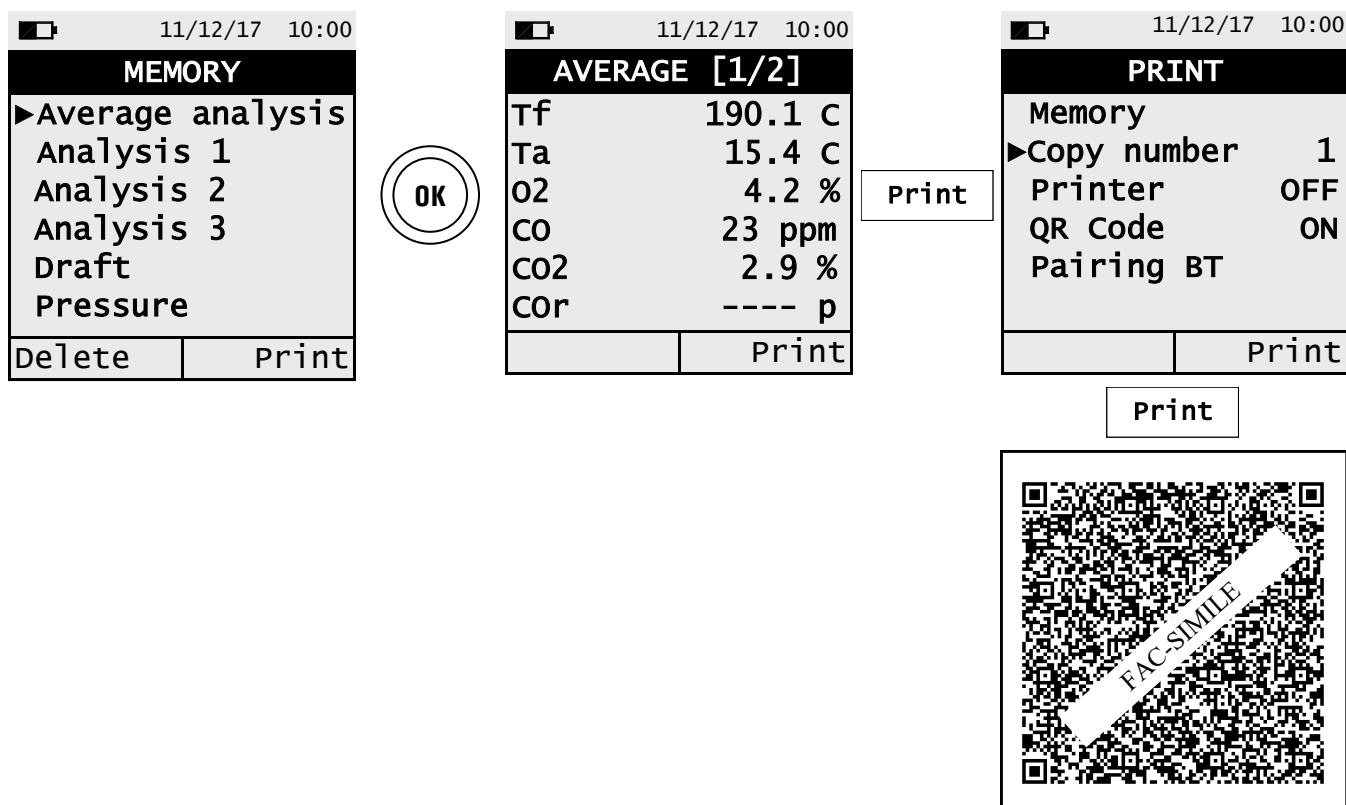

7. Detail of deleting the entire selected memory content

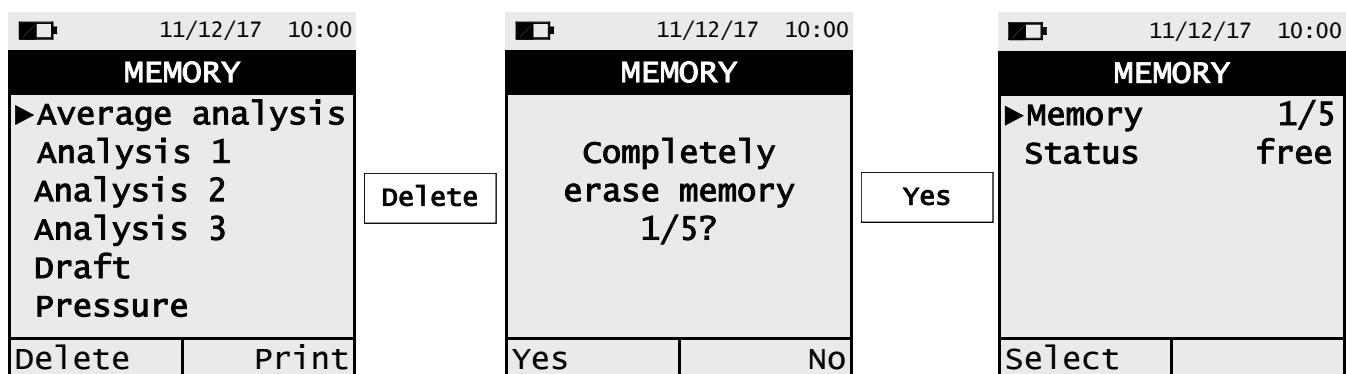

12.1 Menu→Configuration

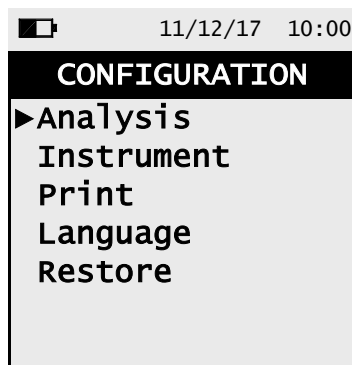

KEY	FUNCTION
	Enters in the selected parameter.
	Selects the available parameters.
	Returns to the previous screen.

SUB MENU	FUNCTION
Analysis	The user, through this menu, can set the different reference parameters of the instrument in order to perform the combustion analysis and/or additional measures. SEE CHAPTER 12.2
Instrument	The user, through this menu, can set the different reference parameters of the instrument. SEE CHAPTER 12.3
Print	This menu allows the user to set the printing parameters, such as copy number, printer type (OFF, BT or IR) and the visualization of the QR code so to download the data of the performed analysis. SEE CHAPTER 12.4
Language	Select the desired language of the instrument for all the menus. SEE CHAPTER 12.5
Restore	Reset default data. SEE CHAPTER 12.6

12.2 Menu→Configuration→Analysis

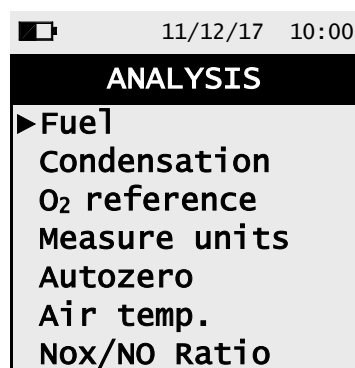

KEY	FUNCTION
	Enters in the selected parameter.
	Selects the available parameters.
	Returns to the previous screen.

SUB MENU	FUNCTION
Fuel	Lets the user select the type of fuel to be used during analysis. SEE CHAPTER 12.2.1
Condensation	The burner efficiency figure when condensation takes place is influenced by atmospheric pressure and humidity of the combustion air. As the atmospheric pressure is hardly precisely known, the operator is asked to enter a related parameter, i.e. the altitude of the place above the sea level, from which the pressure is then derived once the dependency from atmospheric conditions is neglected. In calculations the value of 101325 Pa is assumed as atmospheric pressure at sea level. Further the air relative humidity input is allowed, being this calculated at the combustion air temperature as measured from the instrument; in case this value is unknown the operator is recommended to enter 50% for this value. SEE CHAPTER 12.2.2
O ₂ reference	In this mode the user can set the oxygen percentage level to which pollutant emission values detected during analysis will be referenced. SEE CHAPTER 12.2.3
Measure units	Through this submenu the user can modify the units of measurement for all the analysis parameters, depending on how they are used. SEE CHAPTER 12.2.4
Autozero	In this sub menu it is possible to modify the auto zero cycle duration and the duration of the sensor cleaning cycle which the instrument performs when is turned off. SEE CHAPTER 12.2.5
Air temp.	In this submenu there is a possibility to acquire or manually enter the combustion air temperature. SEE CHAPTER 12.2.6
Nox/NO Ratio (If the instrument version is featured with it)	NOx/NO: all the nitrogen oxides which are present in the flue emissions (Nitrogen oxide = NO, Nitrogen dioxide = NO ₂); total nitrogen oxides = NO _x (NO + NO ₂). In the combustion processes, it is found out that the NO ₂ percentage contained in the gas is not far from very low values (3%); hence it is possible to obtain the NO _x value by a simple calculation without using a direct measurement with a further NO ₂ sensor. The NO ₂ percentage value contained in the gas can be however set at a value other than 3% (default value). SEE CHAPTER 12.2.7

12.2.1 Menu→Configuration→Analysis→Fuel

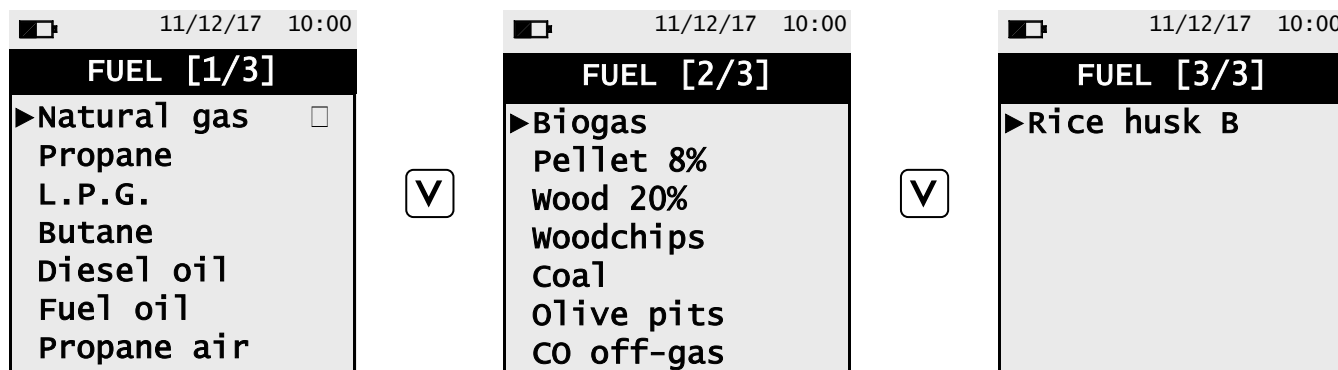

KEY	FUNCTION
	Confirms the choice of fuel to be used during the analysis.
	Scrolls through the available parameters.
	Returns to the previous screen.

Example:

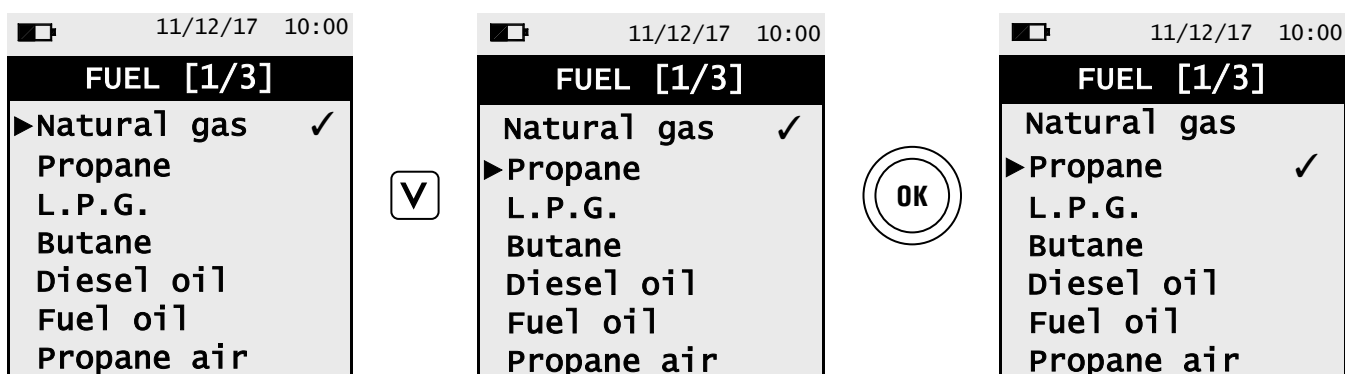

12.2.2 Menu→Configuration→Analysis→Condensation

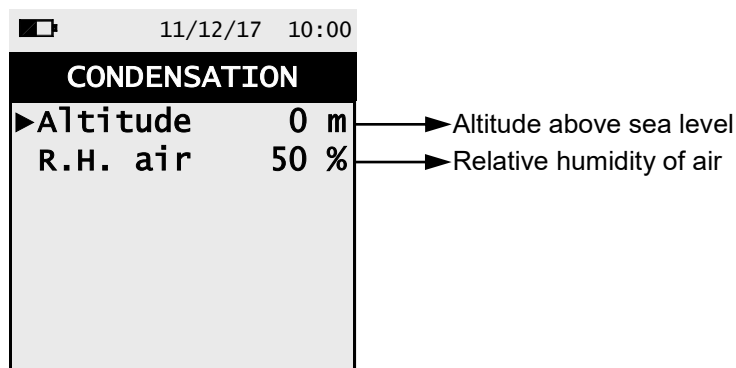

KEY	FUNCTION
	Enters the modify mode for the selected parameter, then confirms the modification.
	The arrows select each line displayed. In edit mode, it scrolls through the suggested values.
	When pressed in modify mode cancels the selection made, otherwise returns to the previous screen.

Example:

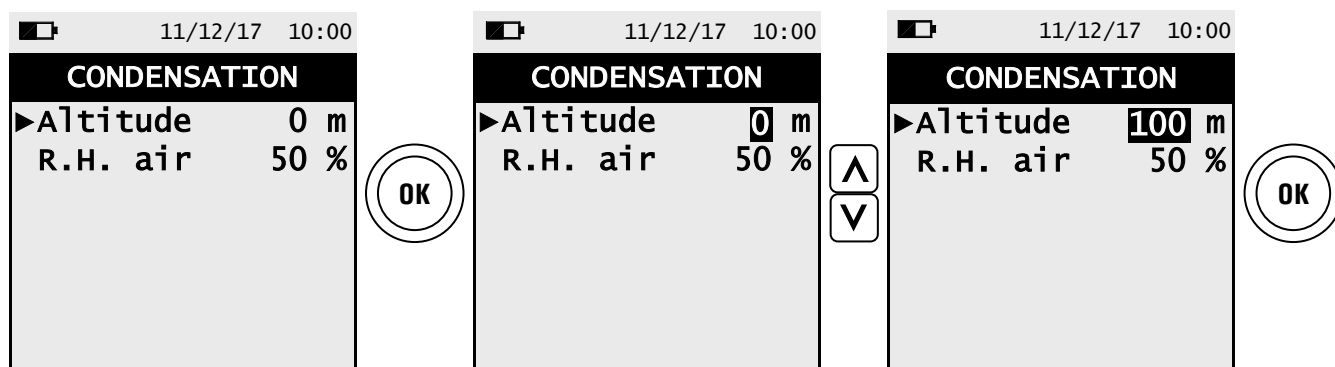

12.2.3 Menu→Configuration→Analysis→O2 Reference

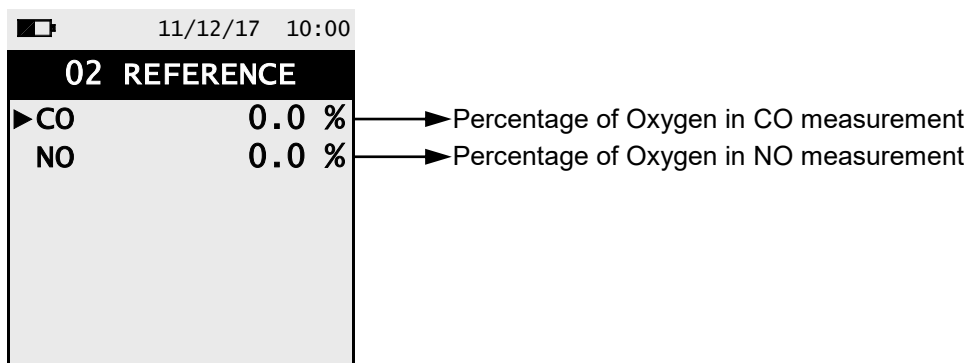

KEY	FUNCTION
	Enters the modify mode for the selected parameter, then confirms the modification.
	The arrows select each line displayed. In edit mode, it scrolls through the suggested values.
	When pressed in modify mode cancels the selection made, otherwise returns to the previous screen.

Example:

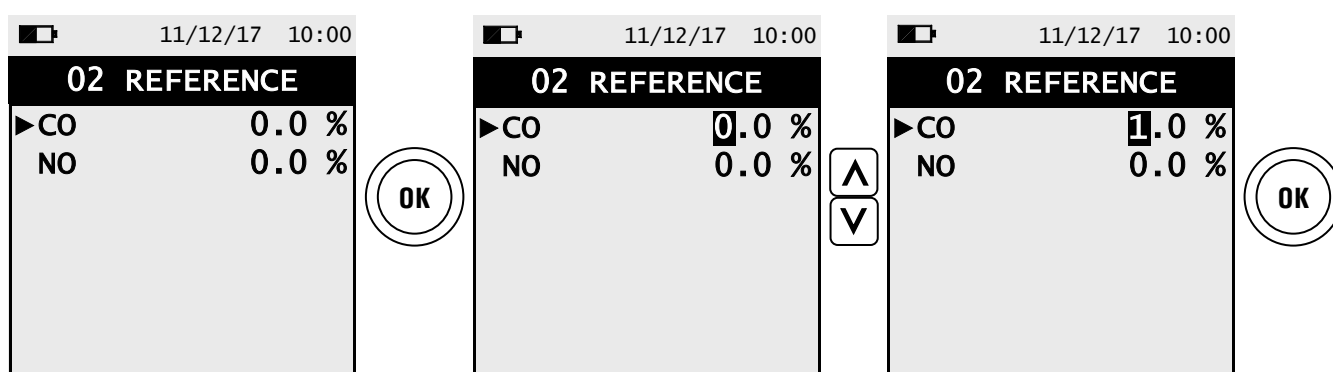

12.2.4 Menu→Configuration→Analysis→Measure units

11/12/17 10:00

MEASURE UNITS

- ▶ CO ppm → Measurement unit can be set as: ppm - mg/m³ - mg/kWh - g/GJ - g/m³ - g/kWh - %
- NO ppm → Measurement unit can be set as: ppm - mg/m³ - mg/kWh - g/GJ - g/m³ - g/kWh - %
- Pressure hPa → Measurement unit can be set as: hPa - Pa - mbar - mmH₂O - mmHg - inH₂O - psi
- Draft Pa → Measurement unit can be set as: hPa - Pa - mbar - mmH₂O - mmHg - inH₂O - psi
- Temperat oC → Measurement unit can be set as: °C - °F
- Altitude m → Measurement unit can be set as: m - ft

KEY	FUNCTION
	Enters the modify mode for the selected parameter, then confirms the modification.
	The arrows select each line displayed. In edit mode, it scrolls through the suggested values.
	When pressed in modify mode cancels the selection made, otherwise returns to the previous screen.

Example:

11/12/17 10:00

MEASURE UNITS

- ▶ CO ppm
- NO ppm
- Pressure hPa
- Draft mmH₂O
- Temperature oC
- Altitude ft

11/12/17 10:00

MEASURE UNITS

- ▶ CO ppm
- NO ppm
- Pressure hPa
- Draft mmH₂O
- Temperature oC
- Altitude ft

11/12/17 10:00

MEASURE UNITS

- ▶ CO mg/m³
- NO ppm
- Pressure hPa
- Draft mmH₂O
- Temperature oC
- Altitude ft

12.2.5 Menu→Configuration→Analysis→Autozero

11/12/17 10:00

AUTOZERO

- ▶Autozero 60 s → Duration of autozero, expressed in seconds.
- Purging 0 s → Duration of the cleaning cycle, expressed in seconds.

KEY	FUNCTION
	When pressed in modify mode cancels the selection made, otherwise returns to the previous screen.
	The arrows sets the desired value. When in modify mode, sets the desired value.
	Enters edit mode of the selected element and then confirms the change.

Example:

11/12/17 10:00

AUTOZERO

- ▶Autozero 60 s
- Purging 0 s

11/12/17 10:00

AUTOZERO

- ▶Autozero 060 s
- Purging 0 s

11/12/17 10:00

AUTOZERO

- ▶Autozero 065 s
- Purging 0 s

12.2.6 Menu→Configuration→Analysis→Air temp

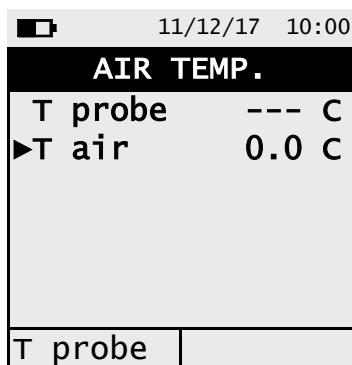

KEY	FUNCTION
	Enters edit mode of the selected element and then confirms the change.
	When in modify mode, sets the desired value.
	When pressed in modify mode cancels the selection made, otherwise returns to the previous screen.

INTERACTIVE OPERATION	DESCRIPTION
T probe	Acquires the detected temperature by the Tc-K probe connected to the instrument and uses it as primary air temperature.

Example with probe connected to the instrument:

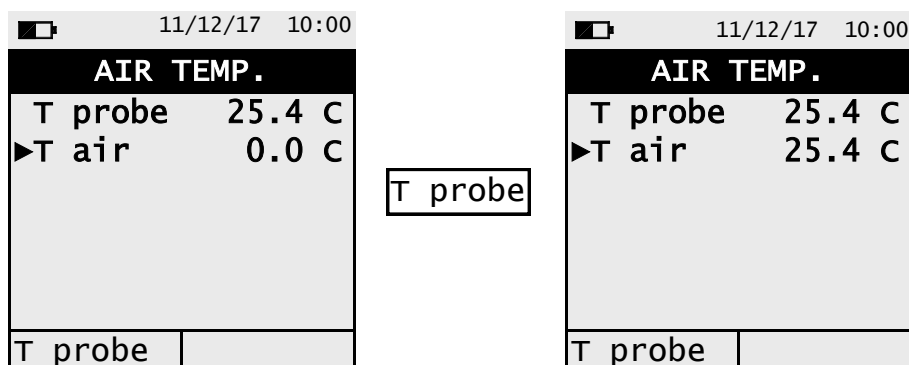

12.2.7 Menu→Configuration→Analysis→NOx/NO Ratio

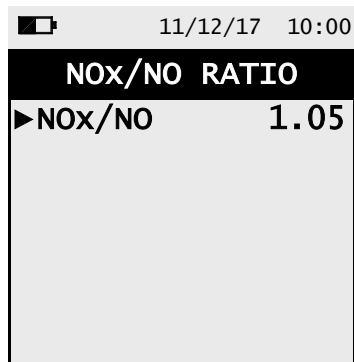

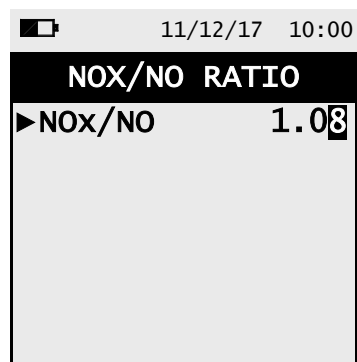
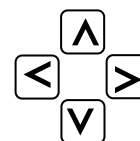
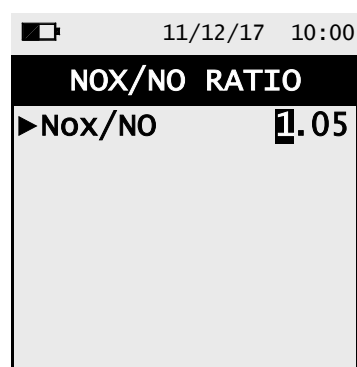
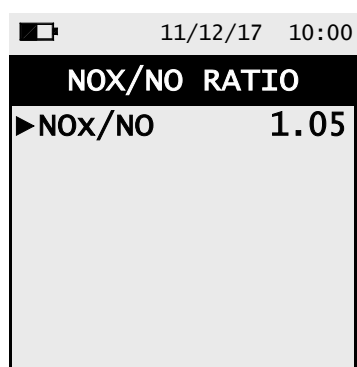

KEY	FUNCTION
	Enters edit mode of the selected element and then confirms the change.
	When in modify mode, sets the desired value.
	When pressed in modify mode cancels the selection made, otherwise returns to the previous screen.

Example:



12.3 Menu → Configuration → Instrument



KEY	FUNCTION
	Enters in the selected parameter.
	Selects the available parameters.
	Returns to the previous screen.

SUB MENU	FUNCTION
Display	With the arrow keys it is possible to increase or decrease the brightness and the contrast of the display. SEE CHAPTER 12.3.1
On site calib.	It is possible to make a recalibration of the instrument's gas sensors with suitable known concentration gas cylinders. Recalibration of Oxygen (O ₂) sensor is not available since it is already recalibrated during every autozero sequence. The access to the sensor recalibration is password protected, the password is '1111'. SEE CHAPTER 12.3.2
Clock	This allows the current time and date to be set. The user can select the date and hour format either in EU (European) or USA (American) mode. SEE CHAPTER 12.3.3
Bluetooth (If the instrument version is provided with it)	In this sub menu it is possible to turn on and off the Bluetooth [®] communication of the instrument and to visualize the related codes. SEE CHAPTER 12.3.4

12.3.1 Menu→Configuration→Instrument→Display

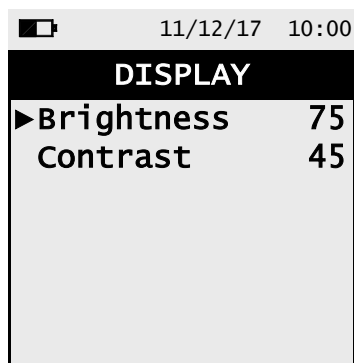



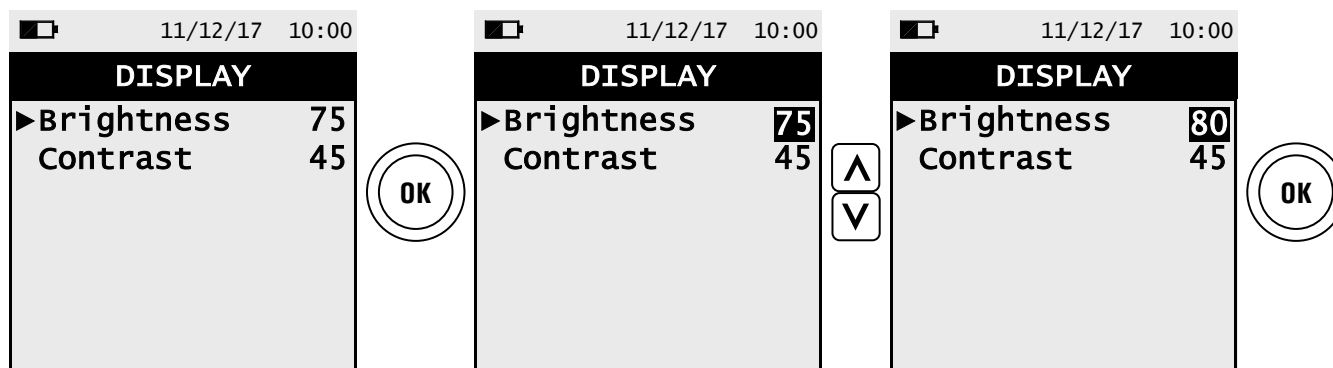

KEY	FUNCTION
	When pressed in modify mode cancels the selection made, otherwise returns to the previous screen.
	The arrows select each line displayed. In edit mode, it scrolls through the suggested values.
	Enters the modify mode for the selected parameter, then confirms the modification.

Example:

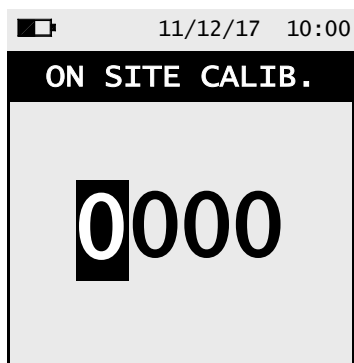

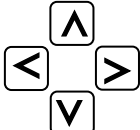
12.3.2 Menu→Configuration→Instrument→On site calib.



KEY	FUNCTION
	Sets the password.
	Selects line; in modification sets the value or the desired mode.
	Once password is entered, gives access to the 'On site calibration' menu.
	Returns to the previous screen. When in modify mode cancels the modification just made.

Calibration procedure

To perform the recalibration the following instruments are needed:

- Known concentration gas cylinder suitable for the sensor, equipped with a pressure regulator
- Flow meter
- Hose with Tee fitting to connect the cylinder to the flowmeter and to the instrument

Following is described a recalibration example for the CO sensor.

1. Start the instrument

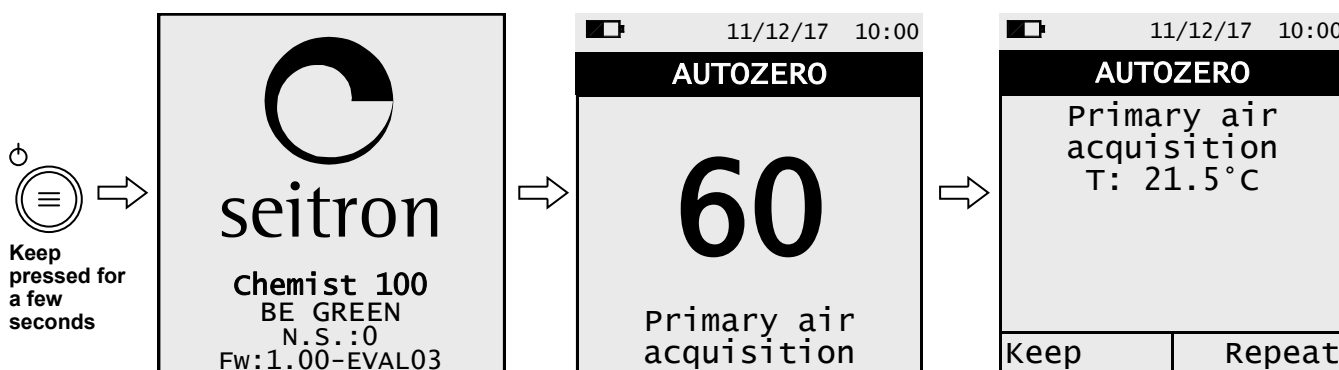

WARNING

- Be sure to perform the autozero in clean fresh air and terminates correctly.
- Do not connect the gas probe to the instrument.
- Check the battery charge level or connect the power adapter to avoid data loss during recalibration.

2. Once autozero is completed press the button and select the menu Configuration→Instrument→on site calib.

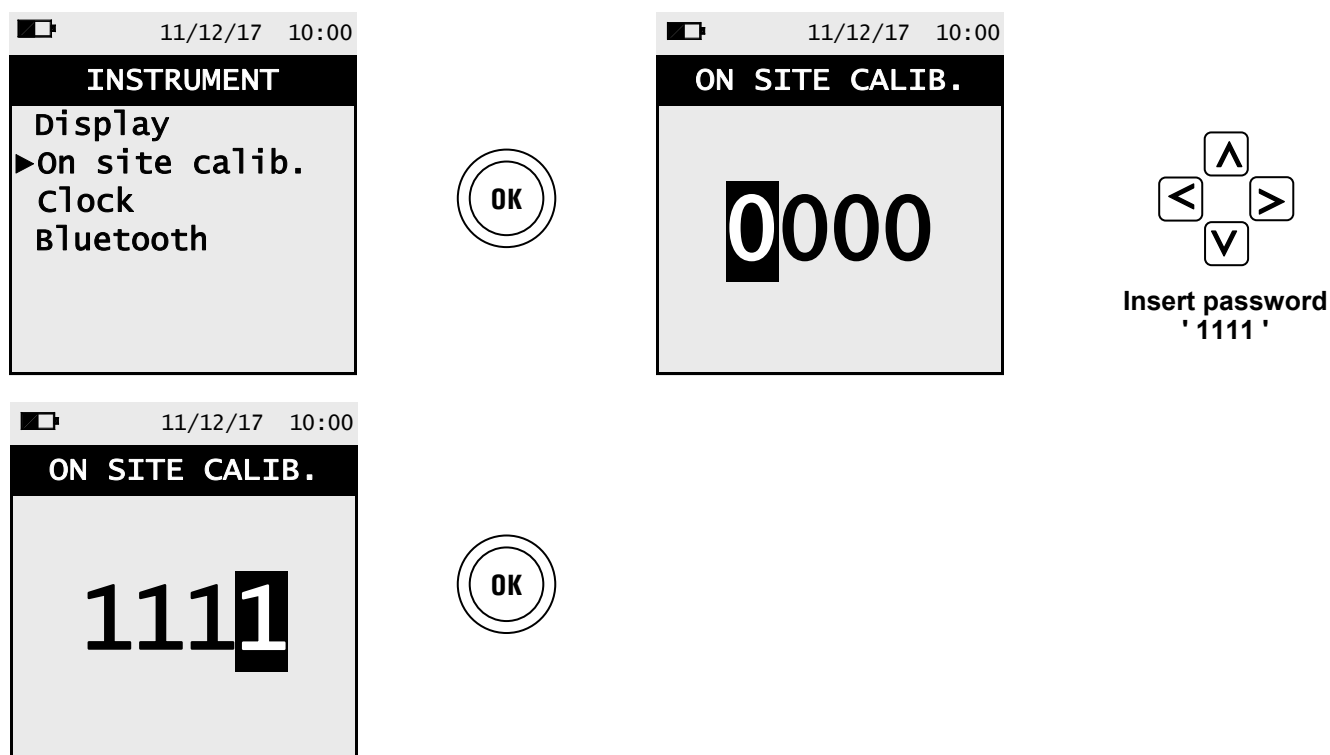

3. Once in the 'On site calibration' menu, is shown the list of the installed sensors for which the recalibration is available. In the recalibration screen all information related to the last performed calibration is shown, as well as the relevant values.

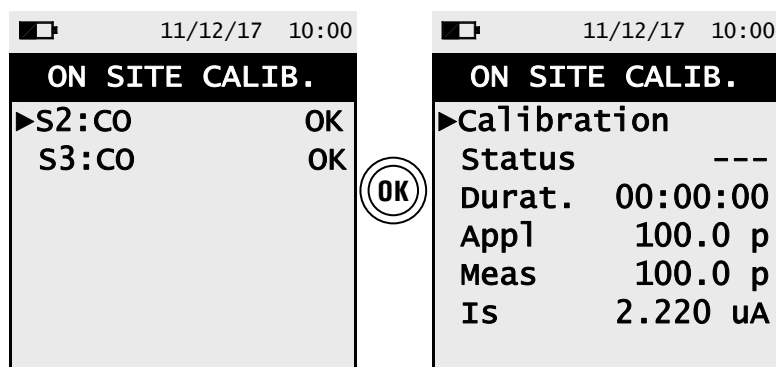

Calibrate: saves new calibration
Status: not active: returns to the factory calibration
 active: returns to the last calibration made by the user
 ----: no 'on site calibration' has been previously stored
Elapsed time: timer
Applied gas: enters the concentration of the applied calibration gas
Measured gas: measures the concentration of the applied gas
Is: 'Is' current from the sensor
Ia: 'Ia' current from the sensor

4. In the following is described in detail a recalibration example for CO sensor.

CHOOSE THE SENSOR TO BE RECALIBRATED AND PROCEED AS DESCRIBED (CO SENSOR EXAMPLE):

- Connect the known concentration gas cylinder to the instrument as shown in the following scheme:

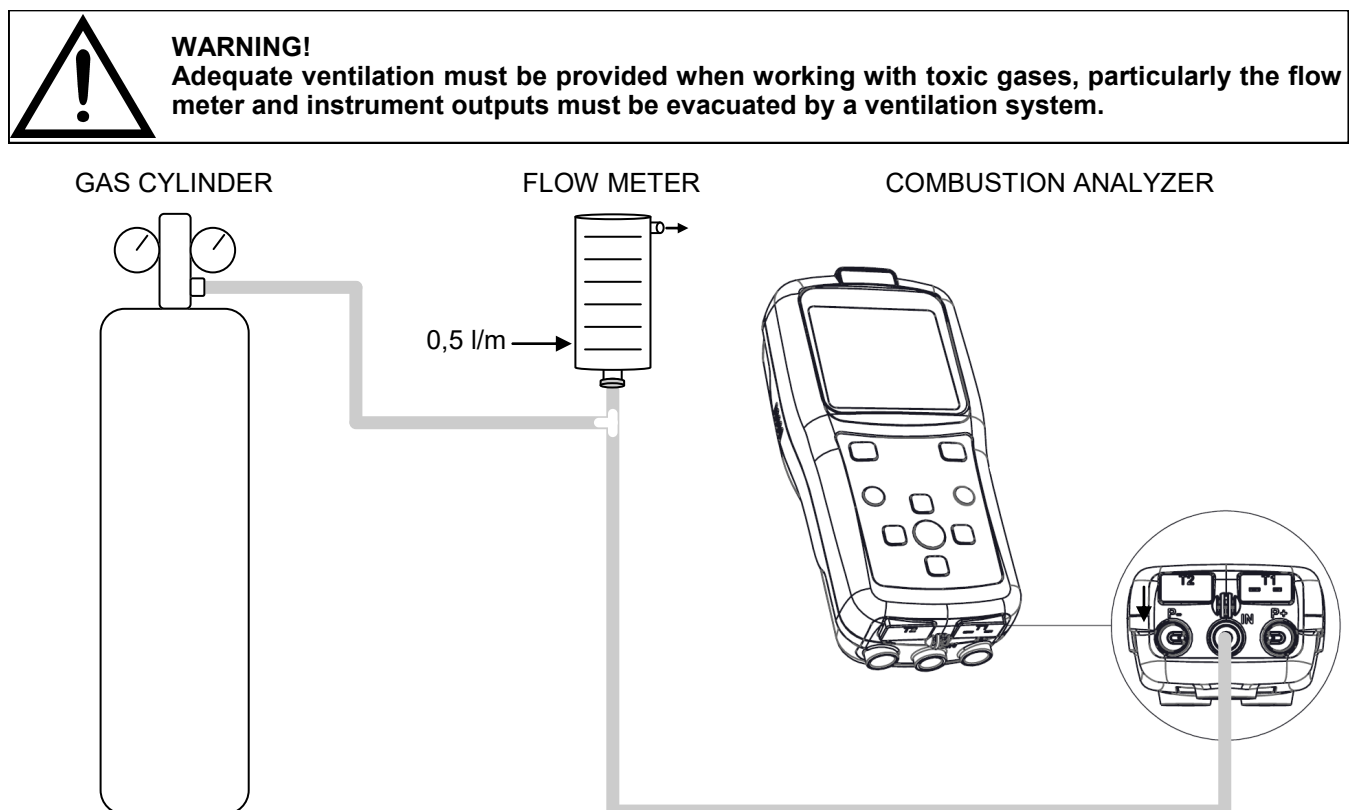

- The calibration will be possible only when the status is set to '----' or 'inactive'.

11/12/17 10:00
ON SITE CALIB.
Calibration
▶Status OFF
Durat. 00:00:00
App1 0 p
Meas 0 p
Is 2.220 uA

11/12/17 10:00
ON SITE CALIB.
Calibration
▶Status OFF
Durat. 00:00:00
App1 0 p
Meas 0 p
Is 2.220 uA

11/12/17 10:00
ON SITE CALIB.
Calibration
▶Status ON
Durat. 00:00:00
App1 0 p
Meas 0 p
Is 2.220 uA

- Enter the value of the concentration of the gas applied.

11/12/17 10:00
ON SITE CALIB.
Calibration
Status ON
Durat. 00:03:00
▶App1 0 p
Meas 0 p
Is 2.22

11/12/17 10:00
ON SITE CALIB.
Calibration
Status ON
Durat. 00:03:50
▶App1 0 p
Meas 0 p
Is 2.22

11/12/17 10:00
ON SITE CALIB.
Calibration
Status ON
Durat. 00:03:50
▶App1 8000 p
Meas 0 p
Is 2.22

- Apply gas to the instrument and adjust the output pressure of the gas from the cylinder so that the flow meter indicates a minimum flow of 0.5 l/m: this guarantees that the instrument is taking the exact amount of gas required by the internal pump. The instrument measures the concentration of gas applied; **wait at least 3 minutes to allow the reading to stabilize**. The reading is shown in line 'Gas measured'.

11/12/17 10:00
ON SITE CALIB.
Calibration
Status ON
Durat. 00:03:60
App1 8000 p
Meas 0 p
Is 2.22

OK
Zeroes the timer
(helps to keep under control the time elapsing during the stabilization phase)

11/12/17 10:00
ON SITE CALIB.
Calibration
Status ON
Durat. 00:00:00
App1 8000 p
Meas 0 p
Is 2.22

- After the stabilization time, select 'Calibrate' and activate the function '  ' to store the new calibration.

ON SITE CALIB.	
▶ Calibration	
Status	ON
Durat.	00:00:00
App1	8000 p
Meas	8000 p
Is	2.22



ON SITE CALIB.	
▶ Calibration	
Status	ON
Durat.	00:00:00
App1	8000 p
Meas	8000 p
Is	2.22

Messages in the 'Status' line:

Saving

the instrument is saving the performed calibration

Error

the sensor has NOT been recalibrated for any of the following reasons:

- The calibration gas cannot properly reach the instrument.
- Concentration for the calibration gas has not been set in the relevant line 'Applied gas'.
- The user didn't allow for the stabilization time to properly elapse.
- The sensor could be damaged or exhausted and must therefore be replaced.



WARNING!

At any time the user can restore the factory calibration in the instrument by setting the 'Status' line on 'not active'.

Below are listed the suggested stabilization times for the 'on site calibration' of the sensors:

CO sensor:	3 minutes
NO sensor:	3 minutes

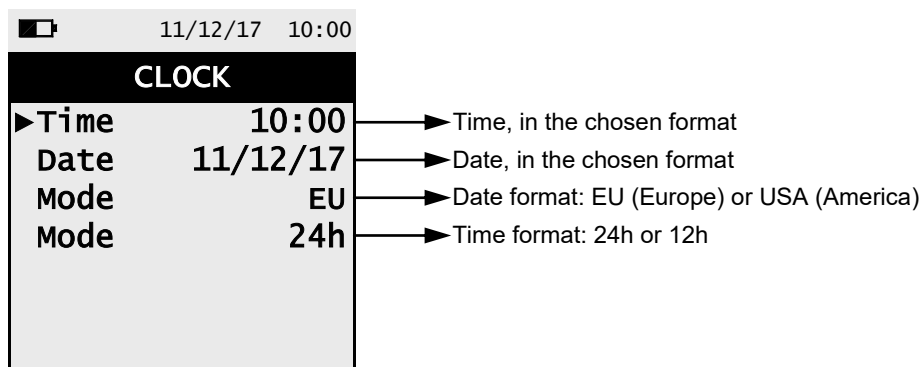

12.3.3 Menu→Configuration→Instrument→Clock



11/12/17 10:00

CLOCK

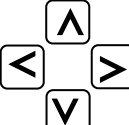

- ▶ Time 10:00 → Time, in the chosen format
- Date 11/12/17 → Date, in the chosen format
- Mode EU → Date format: EU (Europe) or USA (America)
- Mode 24h → Time format: 24h or 12h

KEY	FUNCTION
	When pressed in modify mode cancels the selection made, otherwise returns to the previous screen.
	Selects line; in setting mode, sets the value or the desired mode.
	Enters the modify mode for the selected parameter, then confirms the modification.

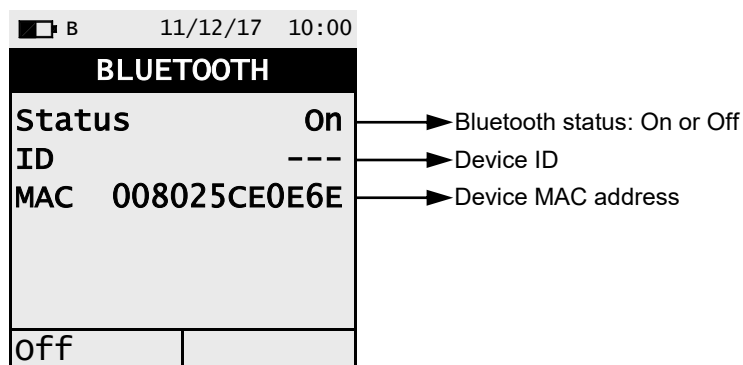
12.3.4 Menu → Configuration → Instrument → Bluetooth (if available)



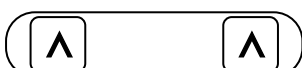

11/12/17 10:00
BLUETOOTH
 Status On → Bluetooth status: On or Off
 ID --- → Device ID
 MAC 008025CE0E6E → Device MAC address
 Off

KEY	FUNCTION
	Activate the context keys shown on the display.
	Goes back to the previous screen.

INTERACTIVE OPERATIONS	DESCRIPTION
Off	Turns off Bluetooth®.
On	Turns on Bluetooth®.

12.4 Menu→Configuration→Print

11/12/17 10:00	
PRINT	
▶Copy number	1
Printer	BT
QR code	ON
Pairing BT	

KEY	FUNCTION
	Enters the modification mode of the selected data and then confirms it.
	Selects the available parameters. In modification mode, scrolls the available values.
	When pressed in modify mode cancels the selection made, otherwise returns to the previous screen.

PARAMETER	DESCRIPTION
Copy number	Sets the number of ticket copy to be printed. This is a valid setting only if a printer has been selected.
Printer	Select the type of printer with which the ticket is printed: BT: Bluetooth® - at the first start up it is necessary to perform the pairing procedure described below. IR: Infrared. OFF: none - the printer is turned off.
QR code	<p>QR code generation: ON: pushing the button related to the interactive function "Print" the instrument generates a QR code, which can be read with the Seitron App "SMARTFLUE LITE MOBILE" and allows to download the data acquired of the performed combustion analyses and the additional measures.</p> <div style="border: 1px solid black; padding: 5px;">  <p>WARNING! The QR code contains the data saved in one memory or the analysis and/or the current measures. In case of Auto mode combustion analysis, the QR code contains the additional measures saved and only the AVERAGE analysis. The data related to each single analysis must be downloaded one by one.</p> </div> <p>OFF: the QR code will not be shown.</p>
Pairing BT	FOR BLUETOOTH® VERSION ONLY Carry out the instrument association procedure to pair the Bluetooth® printer.

12.4.1 Menu→Configuration→Print→Pairing

1. When the Bluetooth printer is set, proceed with the following procedure:

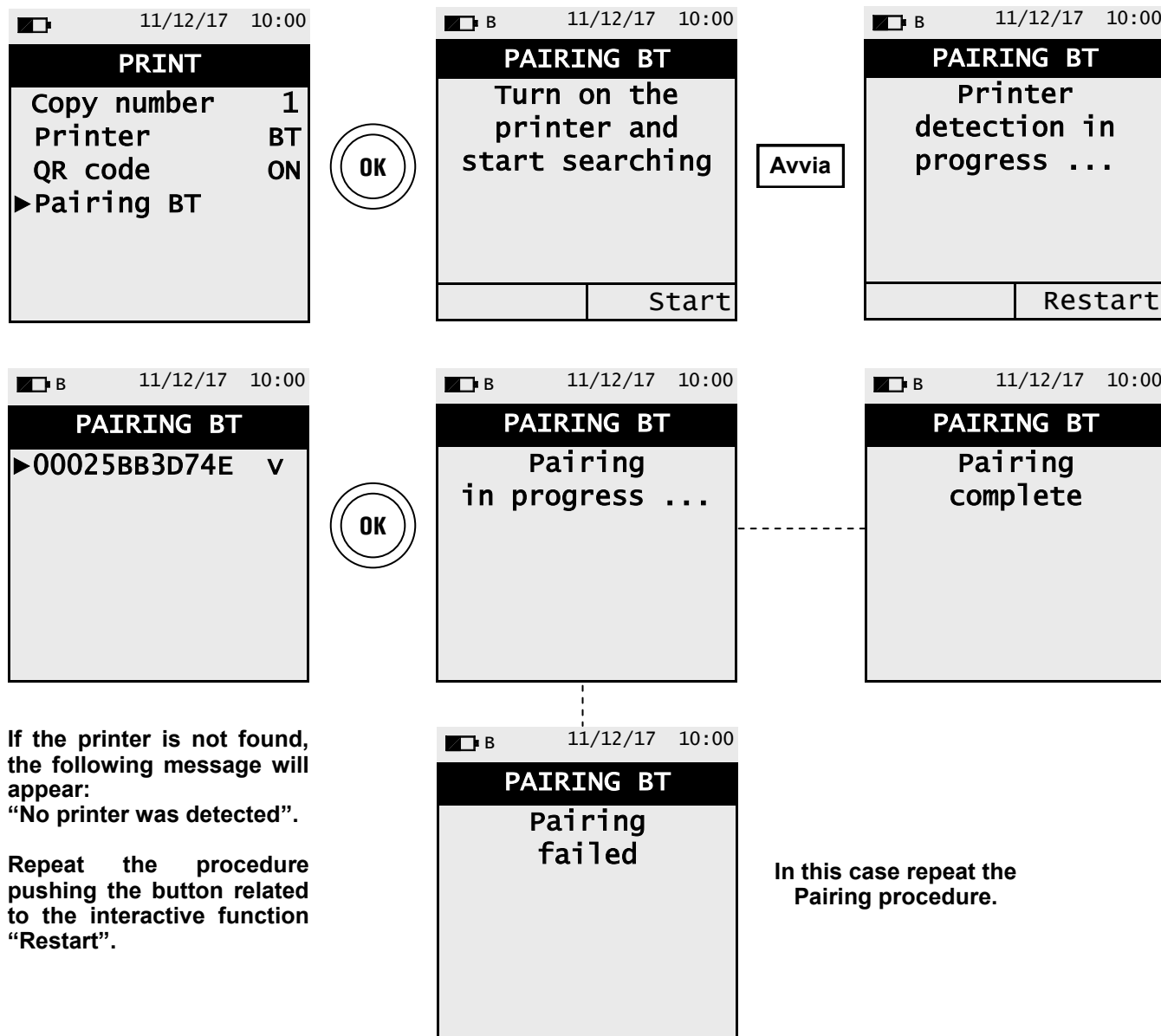

If the printer is not found, the following message will appear:
"No printer was detected".

Repeat the procedure pushing the button related to the interactive function "Restart".

In this case repeat the Pairing procedure.

12.5 Menu → Configuration → Language





KEY	FUNCTION
	Sets the selected language.
	Scrolls through the available languages.
	Returns to the previous screen.

Example:

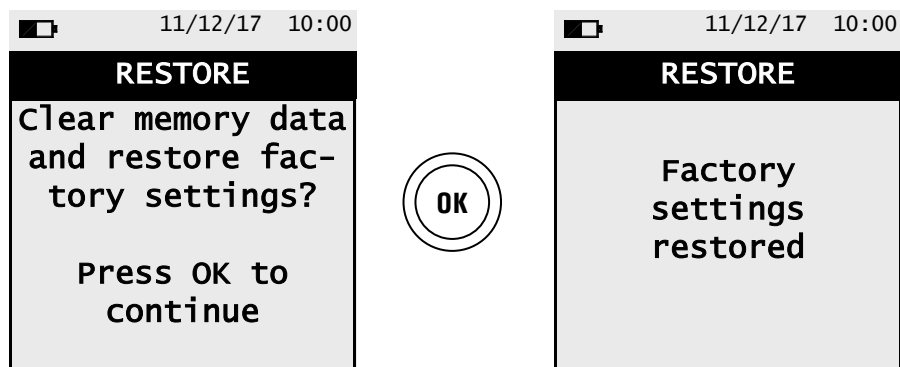

12.6 Menu→Configuration→Restore



KEY	FUNCTION
	Starts the factory data reset phase.
	Exits the current screen without resetting.

13.1 Menu→Diagnostic

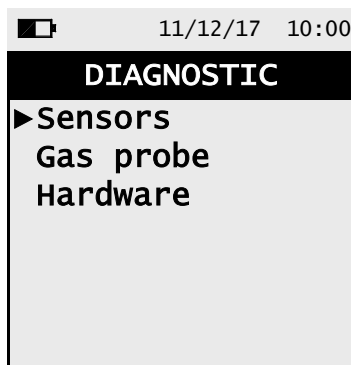

KEY	FUNCTION
	Enters in the selected parameter.
	Selects the available parameters.
	Returns to the previous screen.

SUB MENU	DESCRIPTION
Sensors	<p>Displays information on the state and calibration of the electrochemical sensors:</p> <p>Ok No problem detected absent The sensor was not detected err data Memory data error of the sensor unknown It is necessary to update the FW of the device err pos The sensor has been installed in the wrong position err cal Calibration error (sensor not calibrated) err curr Currents outside the range err cfg Do not use this sensor as it has not been accepted on the screen "types of sensors".</p> <p>Also, from this screen the user can access the identification data of the sensor: type, serial number, date of manufacture and calibration. There are also the measured currents; in this way it is possible to perform a quick diagnosis in the event of a malfunction. SEE CHAPTER 13.2</p>
Gas probe	<p>Tests the tightness of the gas probe pneumatic path. SEE CHAPTER 13.3</p>
Hardware	<p>In case of malfunction, before contacting the Assistance center prepare and/or send the data shown in this menu. SEE CHAPTER 13.4</p>

13.2 Menu→Diagnostic→Sensors

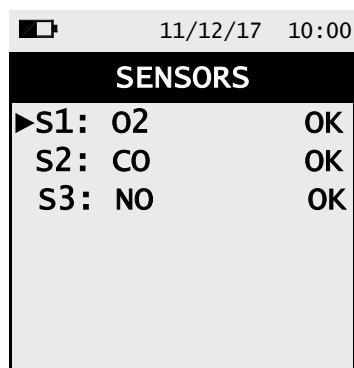

KEY	DESCRIPTION
	Shows the details about the selected sensor.
	Selects the available parameters.
	Returns to the previous screen.

Example:

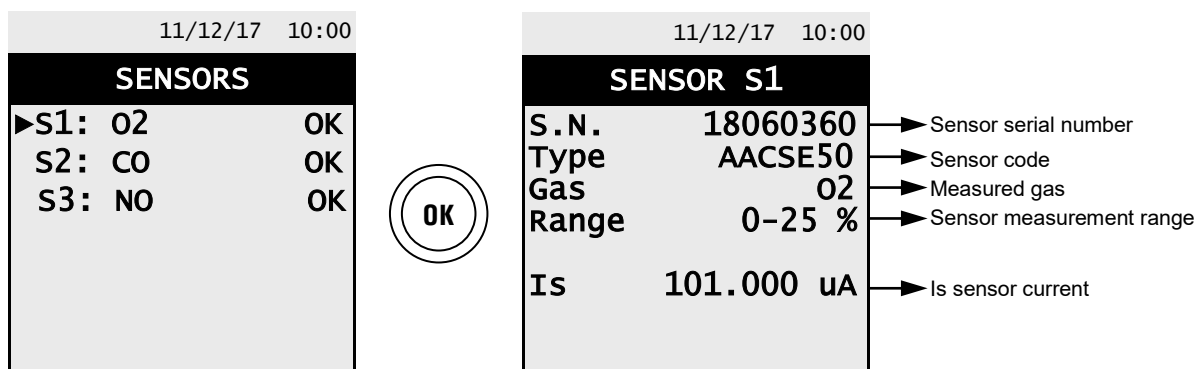

13.3 Menu→Diagnostic→Gas probe

11/12/17 10:00

GAS PROBE

Close the flue gas probe

Press OK to Start

Connect the flue gas sampling probe and filter unit assembly to the instrument;
Fully insert the black rubber cap on the gas probe tip, as shown in the following picture:

KEY	FUNCTION
	Starts the test to check the tightness of the gas sampling probe.
	Returns to the previous screen.

Tightness test of the probe.

11/12/17 10:00

GAS PROBE

Close the flue gas probe

Press OK to start

11/12/17 10:00

GAS PROBE

Calibration

→

11/12/17 10:00

GAS PROBE

Calibration
Probe Test

→

11/12/17 10:00

GAS PROBE

Calibration
Probe Test

Result: Tight

Results:

Tightness: The system is OK

Leak: Make sure that the probe is connected to the input P- or P+, check the seals of the pneumatic connections and/or the seal of the condensation trap and check that the test cap is correctly inserted on the tip of the probe. **WARNING: a damaged probe tip may impair the test.**

Error: It is not possible to perform the test because the sensor is not calibrated.

13.4 Menu→Diagnostic→Hardware



KEY	FUNCTION
	Enters in the selected parameter.
	Selects the available parameters.
	Returns to the previous screen.

INTERACTIVE OPERATIONS	DESCRIPTION
mV	Shows the values in mV.
Bit	Shows the values in Bit.

Visualization example:

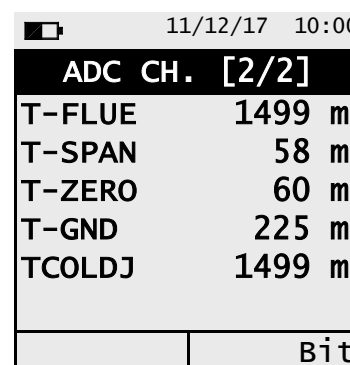
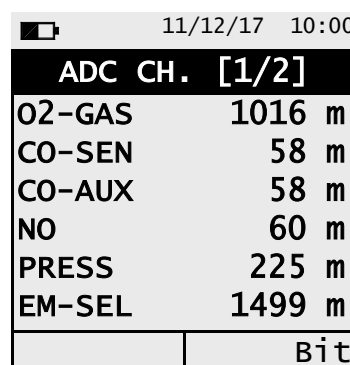
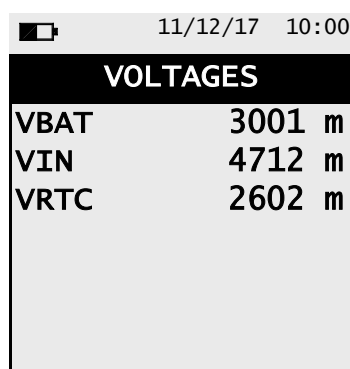

14.1 Menu→Info service

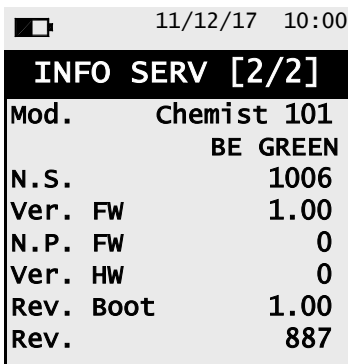

KEY	FUNCTION
	Returns to the previous screen.
 	Toggle view between next or previous screen.

15.1 Gas sensors life

The gas sensors used in this instrument are electrochemical: thus, when the relative gas is detected, a chemical reaction takes place inside them that generates an electrical current.

The electrical current acquired by the instrument is then converted into the corresponding gas concentration. Sensor life is strongly related to the consumption of the reagents within.

Sensor characteristics diminish as the reagents are consumed and when these have been used up completely the sensor must be replaced. The sensors must be recalibrated on a regular basis to assure measuring accuracy: recalibration can only be performed by a qualified SEITRON service centre. Chart 15.2 illustrates the characteristics inherent to each sensor.

15.2 Gas sensors life table

CODE	MEASURED GAS	AVERAGE LIFE	RECALIBRATION
Flex-Sensor O₂ Cod. AACSE55	O ₂ Oxygen	48 mesi	not necessary
Flex-Sensor CO with NO_x filter 0-4000ppm Cod. AACSE54	CO Carbon Monoxide	48 mesi	Yearly ⁽¹⁾
Flex-Sensor CO (high H₂ immunity) 0-4000ppm Cod. AACSE58	CO Carbon Monoxide	>36 mesi	Yearly ⁽¹⁾
Flex-Sensor NO Cod. AACSE60	NO Nitrogen Oxide	48 mesi	Yearly ⁽¹⁾

Notes:

(1) It is advised to calibrate the instrument once a year by sending it to a Seitron assistance center.

16.1 Routine maintenance

This instrument was designed and manufactured using top-quality components. Proper and systematic maintenance will prevent the onset of malfunctions and will increase instrument life altogether.

The following basic requisites are to be respected:

- When the analysis is over extract the sample probe from the stack and let the analyzer draw fresh air for a few minutes, or at least until the displayed parameters return to their original values:
O₂: >20.0%
Toxic gases: <20ppm
- Clean the filter unit when necessary, replacing the particulate filter and applying a jet of air to the sample probe hose to eliminate any condensate that may have formed.

Do not clean the instrument with abrasive cleaners, thinners or other similar detergents.

16.2 Preventive maintenance

At least once a year send the instrument to a SERVICE CENTER for a complete overhaul and thorough internal cleaning.

SEITRON's highly qualified staff is always at your disposal and will provide you with all the sales, technical, application and maintenance details required.

The service centre will always return the instrument to you as new and in the shortest time possible. Calibration is performed using gases and instruments comparable with National and International Specimens. Annual servicing is accompanied by a specific calibration certificate that is a guarantee of perfect instrument performance, and it is indispensable for users wishing to maintain ISO 9000 status.

16.3 Replacing the gas sensors

Periodically it is necessary to replace the instrument gas sensors with new sensors or recalibrated ones.

To replace the sensors it is necessary to send the instrument to Seitron assistance center.

16.4 Replacing the battery pack

Follow these instructions to replace the battery pack:

1 Remove the base of the instrument

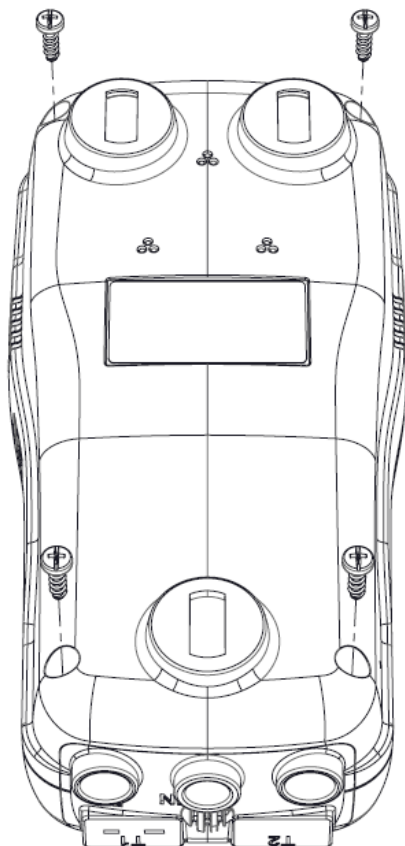

2 Extract the battery pack.

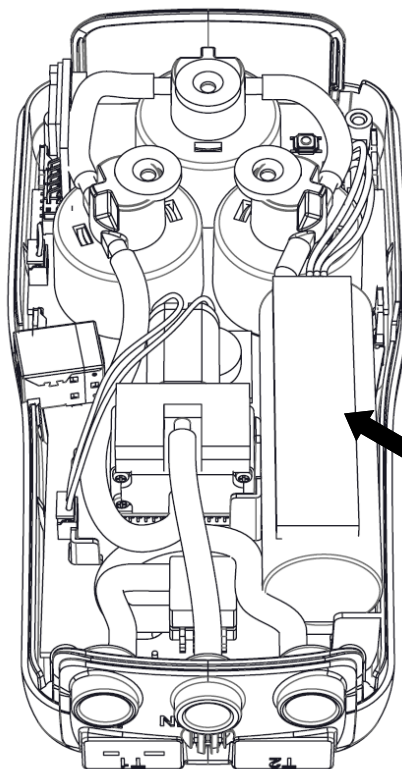

3 Remove the battery pack connector, and replace the pack with a new one following the reverse procedure described above.

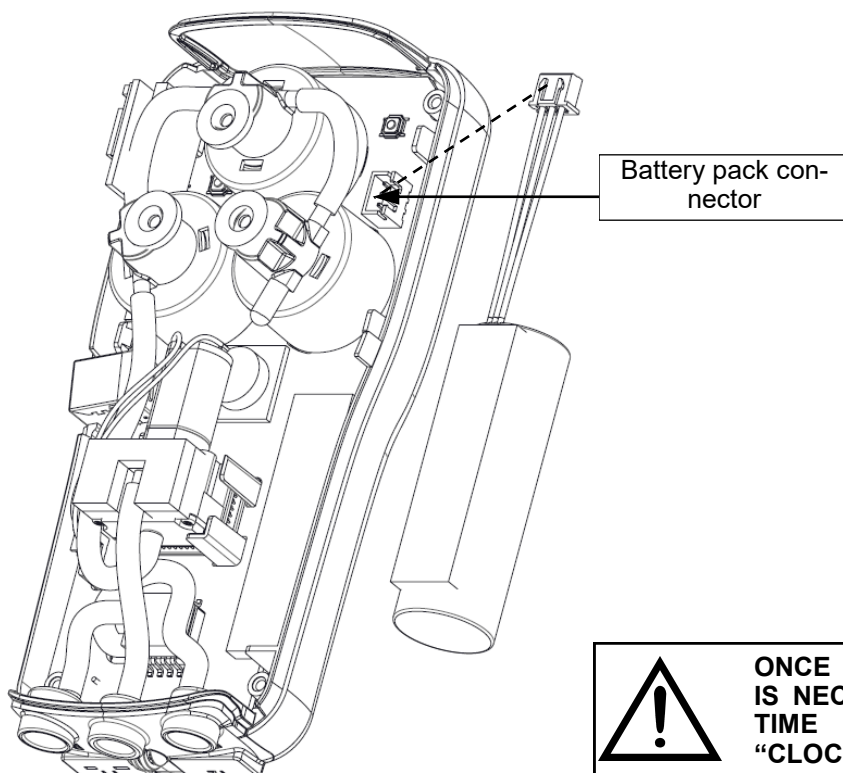

! ONCE THE BATTERY IS REPLACED IT IS NECESSARY TO RESET DATE AND TIME THROUGH THE PARAMETER "CLOCK" ([SEE CHAPTER 12.3.3](#)).



16.5 Firmware Update

The manufacturer periodically releases firmware updates of the instrument in order to correct unavoidable mistakes or improve the instrument performance or add new functions.

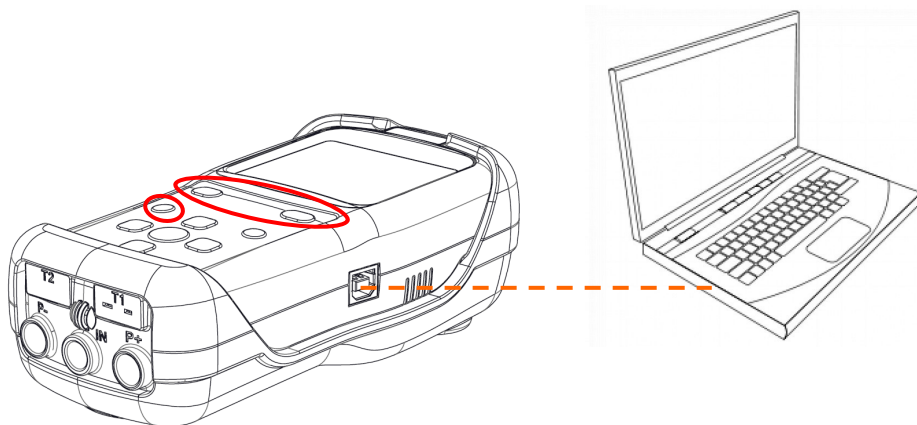

This update can be performed by the user by following the simple instructions below.

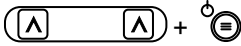
Instructions to update the combustion analyzer with a new firmware:





1. Log in to the website www.seitron.it and download the firmware file available in the "combustion analyzers" section. This file is in a compressed version .zip.
2. Unzip the file thus obtaining the contents of the .zip file (extension .srec)
3. Plug in the analyzer to the PC via the USB cable
4. Hold down the three red buttons on the analyzer for at least 10 seconds:

5. The display turns off
6. Release only the power  button
7. The analyzer will be recognized by the operating system as a portable device drive: the display starts blinking
8. Release the remaining two buttons
9. Copy the firmware file (extension .srec) to the directory of the analyzer: the display continues to blink faster
10. Wait till the end of the file copy operation
11. The file copy directory will be closed and the analyzer will restart
12. The analyzer is now updated, it can be powered off and it can be unplugged from the PC

17.1 Troubleshooting guide

SYMPTOM	PROBABLE CAUSES AND REMEDIES
<p>The instrument does not work at all. Pushing the  button the instrument does not turn on.</p>	<p>a. Press the  for at least 2 seconds.</p> <p>b. The battery is low; connect the battery charger to the instrument.</p> <p>c. The battery pack is not connected to the instrument. Access the internal parts of the instrument and verify that the connector of the battery pack is inserted in the proper connector (SEE CHAPTER 16.4).</p> <p>d. The instrument is faulty: send it to a service center.</p>
<p>The battery symbol is empty on the inside and blinking.</p>	<p>The batteries are low. The instrument will remain on for a couple of minutes after which it will switch off; connect the battery charger.</p>
<p>The instrument battery autonomy is lower than what stated in the “Technical features” chapter.</p>	<p>a. The battery capacity is limited at a low temperature. To obtain a greater autonomy it is advised to keep the instrument in higher temperatures.</p> <p>b. Perform a 100% complete charge cycle connecting the instrument to the plug for at least 6 hrs.</p> <p>c. The battery pack is old. Aging can cause the batteries to reduce their capacity. If the autonomy has become unacceptable change the internal battery with an original part SEITRON.</p> <p>d. Verify the measured tension values in “Menu→Diagnostic→Hardware→Tensions”: - If VBAT<3000mV: the battery needs to be changed. - If VIN<4700mV: the output tension of the battery charger is not sufficient to recharge the instrument battery. In this case verify the connections and the plate data of the battery charger in use: 5Vdc 2A.</p> <p>d. If the problem keeps on happening contact the SERVICE CENTER.</p>
<p>Date and time are not memorized.</p>	<p>a. Verify the tension value VRTC showed in “Menu→Diagnostic→Hardware→Voltages”: If <2600mV contact the SERVICE CENTER.</p> <p>b. The battery is completely drained (VBAT<2500m)</p>
<p>After the autozero, the sensor diagnostic screen appears, which indicates an error in one or more cells.</p>	<p>a. The autozero has been performed while the combustion gas sample was still being taken.</p> <p>b. The O₂ sensor is broken, incorrectly connected or not connected at all. Send the instrument to the service center.</p> <p>c. The waited settling time of the sensor was not enough or the instrument has been left with a low battery charge for a long time.</p>
<p>In the Pressure / Draught screen there is an error of the pressure sensor.</p>	<p>There is a calibration problem. Send the instrument to the service center.</p>

Troubleshooting guide

SYMPTOM	PROBABLE CAUSES AND REMEDIES
In the analysis screen there is an error in the smoke temperature measurement (Tf).	<p>a. Thermocouple not connected; connect the thermocouple to the analyzer.</p> <p>b. The sensor has been exposed to temperature higher or lower than its functioning.</p> <p>c. The thermocouple is faulty. Send the entire probe to the service center.</p>
The following symbol "----" appears on the analysis screen.	The instrument is not able to calculate a numerical value based on the flue gas analysis conducted. The "----" are replaced by numbers when the analyzer detects valid combustion data.
"Max. Lim." or "Min. Lim" appears on the analysis screen.	The relative sensor is detecting a value that is beyond the analyzer measuring range. "Max. Lim" or "Min. Lim." are replaced by numbers when the instrument reveals values that are within the measuring range.
The sample pump sounds as though it is running slowly, tends to stop or does not even start.	<p>a. Sample flow is obstructed. Check that the water filter is clean and that it is not completely soaked. Also check that the hose connected to the probe is not crushed.</p> <p>b. Sample intake flow is obstructed. Check that the particulate filter is clean.</p> <p>c. Pump is disabled. The key combination   has been pressed. To re-enable the pump, switch off the instrument and then switch it on again.</p>
The back lighting of the display does not turn on.	The instrument is faulty. Send it to the service center for repairing.
The values shown in the analysis screen are not reliable.	<p>a. Sensor/s is/are faulty. Check that the sensors are installed correctly by accessing the sensor diagnostics menu.</p> <p>b. The sample probe connection presents a leak. Check all joints and the conditions of the hose.</p> <p>c. The instrument is faulty: Send it to a service center for repairing.</p>

18.1 Spare parts

CODE	DESCRIPTION
AAC FA01	Particulate filter
AA PB13	Li-Ion 7,2V 2,4Ah battery pack

18.2 Accessories

CODE	DESCRIPTION
AA AL05	Power supply 100-240V~/12 VDC 2A with 2 mt cable
AA SI01	Italian plug
AA CA02	Power supply with car adapter
AA CR09	Rigid plastic case
AAC KP01	Differential pressure kit
AA SF71A	180 mm gas probe, maximum working temperature: 400°C, with 2 mt cable
AA SF72A	300 mm gas probe, maximum working temperature: 600°C, with 2 mt cable
AA SX01	Gas sampling probe for average CO, 300mm with 2 m cable
AAC EX02S	3 m extension cable for gas sampling probe
AA SM07	Rubber protective cover
AA SW08	Configuration software kit (USB + PC cable)
AAC TA04	Particulate/water filter assembly
AAC TA04A	Particulate/water filter assembly with steel pipe and connector
AA UA01	Adapter cable USB-A / USB-B

18.3 Service Centers

Seitron S.p.A. a socio unico

Via del Commercio, 9/11
36065 Mussolente (VI) ITALY
Tel.: +39.0424.567842
Fax.: +39.0424.567849
E-mail: info@seitron.it
<http://www.seitron.com>

Seitron Service Milano

Via Leonardo da Vinci, 1
20090 Segrate (MI) ITALY
Tel. / Fax: +39.02.836.476.71
E-mail: service.milano@seitron.it

Data Management with “SMARTFLUE LITE MOBILE” APP

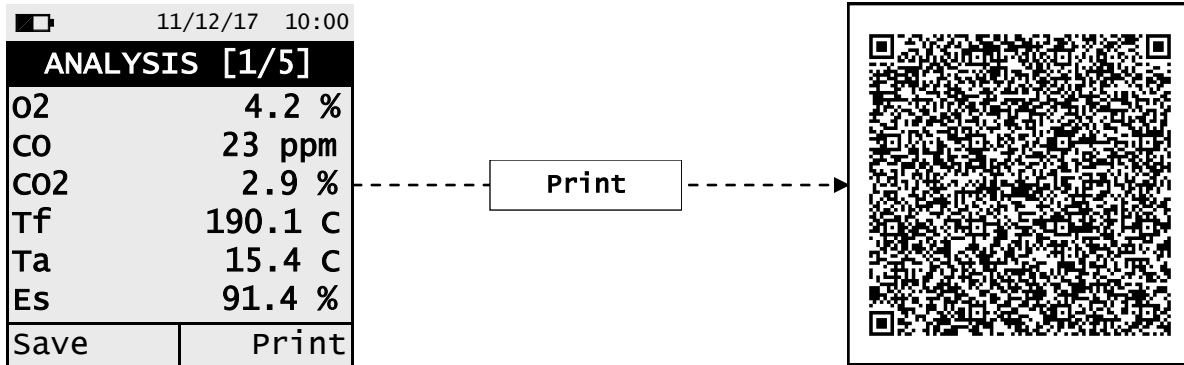

SCAN THE QR CODE USING SEITRON APP “SMARTFLUE LITE MOBILE”, TO DOWNLOAD THE ACQUIRED DATA.

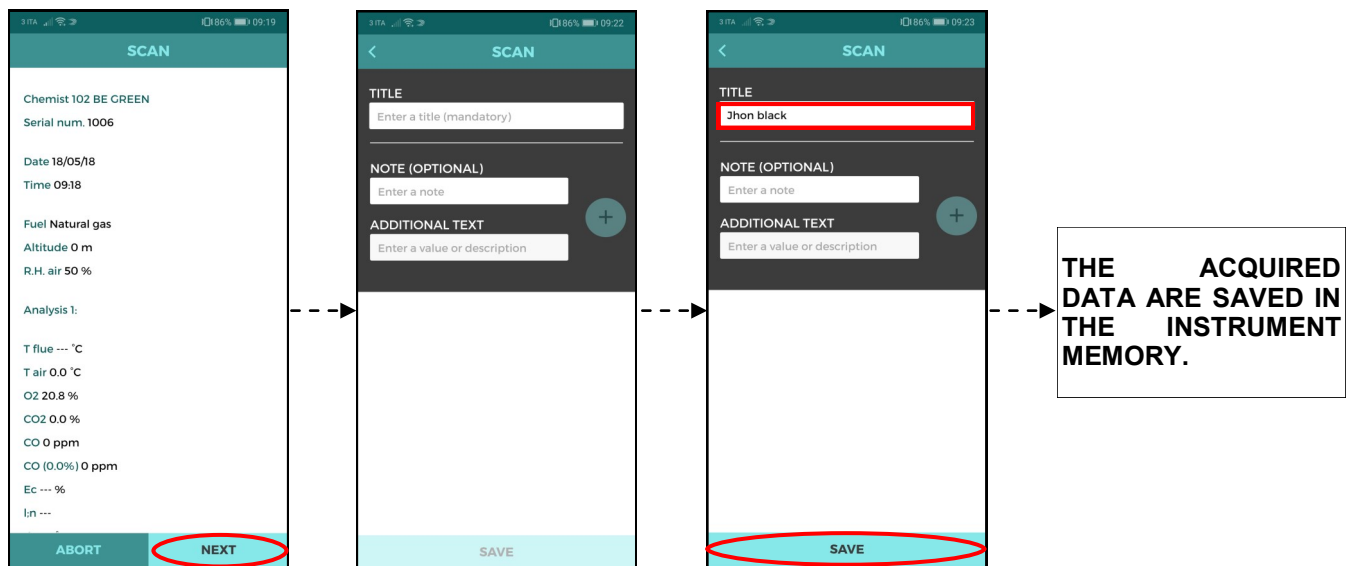

APP settings.

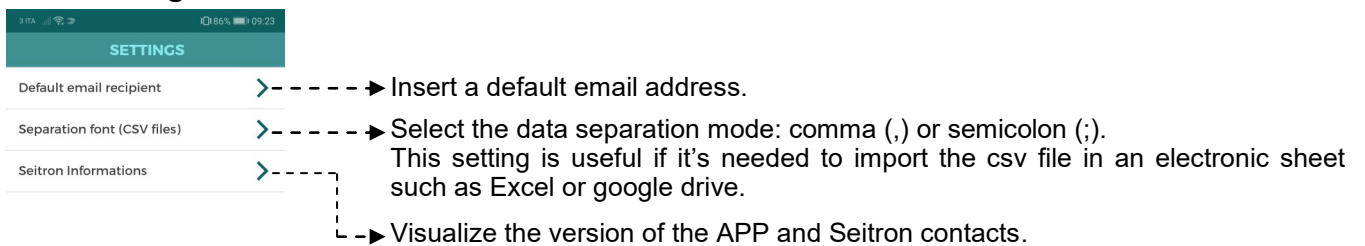

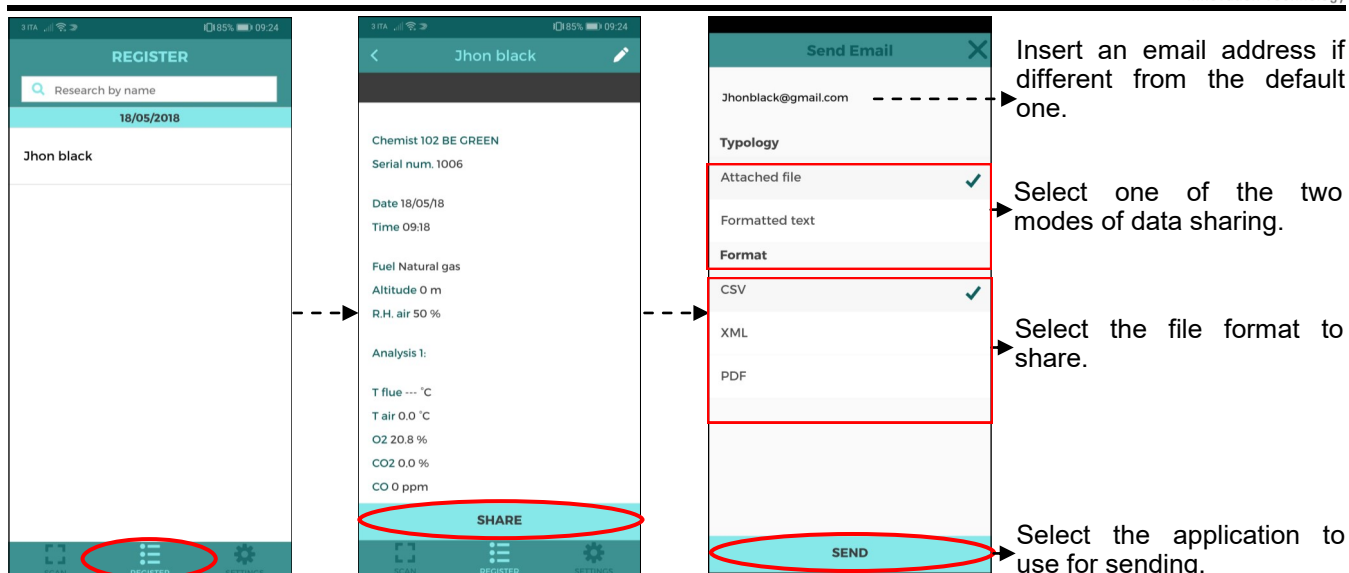

Example of the exported csv file and imported in an excel file:

Chemist 100		
Serial number	1100	
Date	15/12/2017	
Time	12:00	
Fuel	Natural Gas	
Altitud.	0.000000	m
Air HR	50%	
O2	15.7%	
CO	23	ppm
CO2	2.9%	
T smoke	100.6	°C
T air	27.0	°C
ηs	90.0%	
NO	0.000	mV
CO-SEN	258.270	mV
O2	1.131.867	mV
I sen	0.000	uA
I sen	0.000	uA
I sen	100.346	uA
T az	22.5	°C
ΔT	73.6	°C
Qs	10.0%	
λ,n	4.01	
Air excess	4.01	
ηc	0.0%	
ηt	90.0%	
Qs (PCS)	10.0%	
Qt (PCS)	10.0%	
ηs (PCS)	90.0%	
ηc (PCS)	0.0%	
ηt (PCS)	90.0%	
NO	0	ppm
NOx	0	ppm
CO (0.0%)	0	ppm
NO (0.0%)	0	ppm
NOx (0.0%)	0	ppm
Draft	4.5	Pa

Optional measures list:

MEASURE	DEFINITION
λ, n	Air index (defined as λ , sometimes also indicated as n).
e	Air excess. Expressed as a percentage according to the formula in the appendix C, is the ratio between the volume of air actually entering the combustion chamber and the one theoretically needed.
ΔT	Differential temperature: It is the difference between the smoke temperature and the air combustion temperature.
Q_s (LHV)	Stack losses in relation to the Lower Heating Value: It is the percentage of dissipated heat through the stack referred to the lower heating value (LHV)
η_s (LHV)	Sensible efficiency in relation to the Lower Heating Value: It is the burner efficiency calculated as the ratio between conventional heating power and the burner heating power. Among the combustion losses, only the sensible heat lost with flue gasses is taken into account, thus neglecting the radiation losses and incomplete combustion losses. This value is referred to the Lower Heating Value (LHV) of the fuel and cannot exceed 100%. The sensible efficiency value is to be compared against minimum efficiency stated for the heating system performances.
η_c (LHV)	Condensation efficiency in relation to the Lower Heating Value: Efficiency deriving from the condensation of water vapor contained in flue gases it is referred to the LHV.
η_t (LHV) $\eta_t = \eta_s + \eta_c$	Total efficiency in relation to the Lower Heating Value: Total efficiency. It is the sum of sensible efficiency and condensation efficiency. It is referred to LHV (Lower Heating Value) and can exceed 100%.
NO_x	Measure of nitrogen oxides quantity; the measurement unit can be set in the special menu.
NO_x ppm *	Measure of nitrogen oxides quantity; the measurement unit can not be set but it is fixed in ppm.
NO_x (rif. O ₂)	Measure of nitrogen oxides quantity referring to O ₂ ; the measurement unit can be set in the special menu.
NO_x (rif. O ₂) ppm *	Measure of nitrogen oxides quantity referring to O ₂ ; the measurement unit can not be set but it is fixed in ppm.
PI	Poison Index (CO/CO₂ ratio): It is defined as the ratio between CO and CO ₂ useful to determine whether the system needs maintenance.
CO	CO quantity measurement. Measurement units: ppm - mg/m ³ - mg/kWh - g/GJ - g/m ³ - mg/kWh - %
CO (RIF)	CO quantity measurement with O ₂ reference. Measurement units: ppm - mg/m ³ - mg/kWh - g/GJ - g/m ³ - g/kWh - %

* : Valid for Piemonte region only (Italy only).

Measurement units matching → abbreviations

ppm	p
mg/m ³	g
mg/Kwh	w
g/m ³	G
g/Kwh	W
g/GJ	J
hPa	h
Pa	P
mbar	b
mmH ₂ O	H
mmHg	g
inH ₂ O	i
psi	p
°C	C
°F	F
m	m
ft	ft

Coefficients of the fuels and Formulas

The following chart lists the coefficients of the memorised fuels, used for calculating losses and efficiencies.

Coefficients for calculating combustion efficiency									
Fuel	A1	A2	B	CO ₂ t (%)	PCI (KJ/Kg)	PCS (KJ/Kg)	M air (Kg/Kg)	M H ₂ O (Kg/Kg)	V dry gas (m ³ /Kg)
Natural gas	0,660	0,380	0,0100	11,70	50050	55550	17,17	2,250	11,94
Propane	0,630	0,420	0,0080	13,90	45950	49950	15,61	1,638	11,11
L.P.G.	0,630	0,420	0,0080	13,90	45730	49650	15,52	1,602	11,03
Butane	0,630	0,420	0,0080	13,90	45360	49150	15,38	1,548	10,99
Diesel oil	0,680	0,500	0,0070	15,10	42700	45500	14,22	1,143	10,34
Fuel oil	0,680	0,520	0,0070	15,70	41300	43720	13,73	0,990	10,06
Propane air	0,682	0,447	0,0069	13,76	28250	30700	9,13	0,999	6,77
Biogas	0,719	0,576	0,0086	16,81	19200	21250	6,38	0,840	5,82
Pellets (8% RH)	0,740	0,670	0,0071	19,01	18150	19750	6,02	0,660	4,58
Wood (20% RH)	0,761	0,686	0,0089	18,93	15450	17170	5,27	0,700	4,01
Chipped wood	0,8020	0,785	0,0108	20,56	11950	13565	4,20	0,660	3,25
Coal	0,7620	0,691	0,0023	19,06	31400	32300	10,70	0,370	8,14
CO Off gas	0,775	1,164	0,0012	31,55	8610	8735	2,21	0,051	2,14
Olive pits	0,749	0,689	0,0065	19,33	18780	20309	6,290	0,626	4,79
Rice husk	0,777	0,768	0,007	20,74	12558	13633	4,065	0,440	3,15

Details of the coefficients of the fuels:

- **CO₂ t:** The value of CO₂ generated by combustion in stoichiometric condition, i.e. without excess Oxygen and therefore maximum.
- **A1, A2, B:** Also please have a look at the Siegert formulas from the European standard EN50379-1 (in the following).
A1 is the parameter in the Siegert Formula when the O₂ measurement is available.
A2 is used when the CO₂ measurement is available.
Note: - Please also consider that in the U.S. usually the A1 parameter is the same as the 'European' A1 BUT divided by 2.
- For Germany coefficients A1 and A2 are swapped.

$$q_A = (t_A - t_L) \times \left(\frac{A1}{21 - O_2} + B \right)$$

Flue gas heat losses are calculated from measured oxygen content according to the relationship:

$$q_A = (t_A - t_L) \times \left(\frac{A2}{CO_2} + B \right)$$

Air index is calculated with the formula:

$\lambda = 21 / (21 - O_2)$, where O₂ is the oxygen residual concentration in the combustion smokes.

Air excess is calculated with the formula:

$$e = (\lambda - 1) * 100$$

Flue gas heat losses are calculated from measured carbon dioxide content according to the relationship:

- **CO conv:** Conversion coefficient from ppm to mg/KWh. It can be expressed as a function of the gas density (CO in this case) and the volume of the dry smoke.
- **NO conv:** Same as CO conv, but for NO.
- **NO_x conv:** Same as CO conv, but for NO_x.
- **SO₂ conv:** Same as CO conv, but for SO₂.
- **PCI:** Potere Calorifico Inferiore. Italian for LHV (Lower Heating Value).
- **PCS:** Potere Calorifico Superiore. Italian for HHV (Higher Heating Value).
- **m H₂O:** Mass of the air produced (per each Kg of fuel) in the combustion in stoichiometric condition.
- **m Air:** Mass of the air needed for combustion in stoichiometric condition.
- **V g.d.:** Volume of dry smokes produced in the combustion.

 Innovation Technology Tel. (+39).0424.567842 Fax. (+39).0424.567849	DICHIARAZIONE DI CONFORMITA' UE EU DECLARATION OF CONFORMITY	Nr. 029892 Pag. 01 di 01
Nome del fabbricante: Seitron S.p.A. a socio unico <i>Constructor name:</i>		
Indirizzo del fabbricante: Via del Commercio, 9/11 <i>Constructor address:</i> 36065 MUSSOLENTE (VI) ITALIA		
dichiara sotto la propria esclusiva responsabilità che il seguente prodotto: <i>declares under its sole responsibility that following product:</i>		
Nome del prodotto: K1 <i>Product name:</i> Analizzatore di combustione <i>Combustion analyzer</i>		
Versioni del prodotto: Tutte <i>Product versions:</i> All Nomi commerciali: Chemist 10- - BE GREEN <i>Sales models:</i>		
e' conforme alla pertinente normativa di armonizzazione dell'Unione: <i>is in conformity with the relevant Union harmonisation legislation:</i>		
EMC (2014/30/UE): EN-50270 (2006)		
LVD (2014/35/UE): EN 60335-1 (2012) (Per le parti citate nella norma di prodotto) <i>(For parts mentioned in the Product Standard)</i>		
Di prodotto: EN 50379-1 (2012) <i>(Product):</i> (Requisiti generali e metodi di prova) <i>(General requirements and test methods)</i> EN 50379-2 ¹ (2012) (Requisiti specifici per apparecchi impiegati per ispezioni e analisi valutazioni obbligatorie) <i>(Performances requirements for apparatus used in statutory inspections and assessment)</i> EN 50379-3 ² (2012) (Requisiti specifici per apparecchi impiegati in ambito non legale per la manutenzione di apparecchi di riscaldamento a gas) <i>(Performances requirements for apparatus used in non-statutory servicing of gas fired heating appliances)</i>		
RoHS2 (2011/65/UE): EN-50581 (2012) Per i sensori di O ₂ elettrochimici vale l'esenzione di cui all'Allegato IV, punto 1b. <i>Electrochemical O₂ sensors are exempted according to Annex IV, point 1b.</i>		
Note aggiuntive: Lo strumento è conforme alle norme italiane UNI 10845, per la misura del tiraggio ed UNI 10389-1, per la misurazione del rendimento di combustione. <i>Further notes:</i> <i>This instrument is compliant with the requirements of the Italian standard UNI 10845, for draft measurement, and UNI 10389-1, for combustion efficiency measurement.</i>		
Mussolente, li 22/03/18		
1 Valido per le configurazioni che includono uno o più dei seguenti sensori: <i>Valid for configurations equipped with one or more of the following sensors:</i> O ₂ : Qualunque codice / All codes CO: Cod. AAC SE58 NO (optional): Cod. AAC SE80 2 Valido per le configurazioni che includono uno o più dei seguenti sensori: <i>Valid for configurations equipped with one or more of the following sensors:</i> O ₂ : Qualunque codice / All codes CO: Cod. AAC SE54 NO (optional): Cod. AAC SE60		
Seitron S.p.A. a socio unico Via del Commercio, 9/11 36065 Mussolente (VI) Italy Tel. (+39).0424.567842 Fax. (+39).0424.567849		



WARRANTY CERTIFICATE

WARRANTY

The CHEMIST 100 BE GREEN flue gas analyzer is guaranteed for **24 months** from purchasing document date including the electronic parts, the internal electro-chemical sensors and the printer.

Seitron undertakes to repair or replace, free of charge, those parts that, in its opinion, are found to be faulty during the warranty period. The products which are found defective during the above mentioned periods of time have to be delivered to Seitron's Laboratories carriage paid. The following cases are not covered by this warranty: accidental breakage due to transport, inappropriate use or use that does not comply with the indications in the product's instruction leaflet.

Any mistreatment, repairs and modifications to the product not explicitly authorized by Seitron shall invalidate the present warranty.

IMPORTANT

For the product to be repaired under Warranty, please send a copy of this Certificate along with the instrument to be repaired, together with a brief explanation of the fault observed.

Space reserved for user

Name: _____

Company: _____

User's notes:

Date: _____

S.N.:



Via del Commercio 9/11 - 36065 - Mussolente (VI) - Tel. (+39).0424.567842 - Fax. (+39).0424.567849



SEITRON S.p.A. a socio unico

Indirizzo: Via del Commercio, 9/11
36065 - Mussolente (VI)
ITALIA

Tel.: +39.(0)424.567842

Fax: +39.(0)424.567849

E-mail: info@seitron.it

Sito Web: www.seitron.com